



MACHINE VISION LENS

PRODUCT GUIDE



computer[®]

NEW PRODUCTS

MPY series

V0828-MPY



V1228-MPY



V1628-MPY



V2528-MPY



V3528-MPY



V5028-MPY



1.1" 12 MEGAPIXEL C-MOUNT LENS

- 8, 12, 16, 25, 35, 50mm. 6 Lens Series
- Compatible with 1.1" (ϕ 17.6mm) Large Format Sensor
- Ultra-High Resolution 12MP
- Compact 1.1" Design (smallest 12MP lens in the industry)
- Locking Screw for Focus and Iris

MPW2 series

M0824-MPW2



M1224-MPW2



M1620-MPW2



M2518-MPW2



M3520-MPW2



M5028-MPW2



TEC series

TEC-V7X



TEC-M55MPW



TEC-M55



5 MEGAPIXEL C-MOUNT LENS

- Ultra low distortion.
- Higher relative illumination rate
- Compact design
- Locking screws for focus and iris.
- JIA Standard 5 megapixel A-rank.

TELECENTRIC LENS

- Low distortion
- For large sensor format (2/3" and 1.1")
- Higher relative illuminance.

Introduction

When setting up your vision system, the lens may be one of the last components you choose. Once your system is up and running, however, **your data flows from the lens first.** That makes lens choice one of the most impactful decisions that will determine how well your vision system works for you. With the success of your next project on the line, turn to a partner with over 40 years of experience in precision-engineered optics.

Computar's Factory Automation line of lenses is engineered to meet the challenges of the most demanding vision systems. Featuring an unrivaled compact form factor, ultra-low distortion optics and a robust design meant to last decades, Computar lenses are quality you can count on. And with multiple format, resolution and iris options, Computar has the right fit for your application.

Don't let the lens be the weak link in your system. Choosing a great lens tailored to your system's needs can be daunting, but that's what we're here for. Talk to a lens specialist at Computar today and find out how we can assist in selecting the correct lens that will not only work with your system, but expand its potential.

In addition to high-quality products, we focus on creating an unparalleled service experience for our customers. Our sales and technical support staff operate across a vast network; meaning day or night a lens expert is a phone call away in a town near you. This, combined with our first-class inventory system, allows you to rapidly select, receive and integrate Computar lenses into your application.

With a solid foundation based on Japanese engineering and agile production facilities spanning the globe, we operate under a dual mandate to create the highest-quality optics products at an economical price point that works within your budget.

In the following pages, you'll find out more about the product family that has made Computar the gold standard in optics across a variety of industries.

We encourage you to contact us about any of our products, and find out for yourself how choosing Computar will enable your application to **See Everything. Clearly.**

CONTENTS

2/3" MEGAPIXEL LENS (MP / MP2 Series)	03
2/3" 5 MEGAPIXEL ULTRA LOW DISTORTION LENS (MPW / MPW2 Series)	07
1.1" 12 MEGAPIXEL LENS (MPY Series)	11
1" 2 MEGAPIXEL LENS (MP Series)	14
MACRO ZOOM / TELECENTRIC LENS	17
ACCESSORIES	22
SWIR / ITS LENS	23
MEGAPIXEL BOARD LENS	27
TECHNICAL INFORMATION	29

C-MOUNT
1/2" 2/3"
1.5MP

MEGAPIXEL LENS

MACHINE VISION LENS

- Captures full resolution of megapixel cameras
- Low distortion (Less than 1.0%)
- Locking set screws for focus and iris
- High contrast & sharp picture in all areas of the screen
- Compact design-Diameter 33.5mm (H0514-MP : 44.5mm)

H0514-MP2

- 1/2"
- 1.5MP
- FIX
- MANUAL
- WIDE

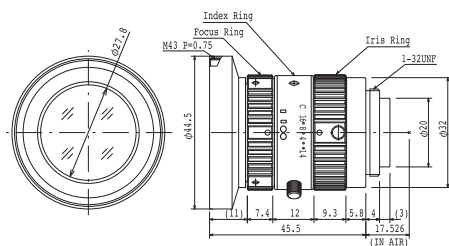

Focal Length	5mm				
Max. Aperture Ratio	1:1.4				
Max. Image Format	6.4mm x 4.8mm (φ8mm)				
Operation Range	Iris	F1.4 - F16C			
	Focus	0.1m - 0.9m			
Control	Iris	Manual			
	Focus	Manual			
Object Dimension at M.O.D.	15.0(H)cm x 11.1(V)cm 1/2"				
Angle of View	D	76.7°	62.3°		
		51.4°	39.5°		
	H	1/2"	65.5°	1/3"	51.4°
		V	51.4°		
Operating Temperature	-10° C ~ +50° C				

Distortion	1/2"	-0.48% (y=4.0)	1/3"	-2.26% (y=3.0)
BackFocal Length	10.8mm (WD=900mm)			
Flange Back Length	17.526mm			
Mount	C-Mount			
Filter Size	M43 P=0.75mm			
Dimensions	φ 44.5mm x 45.5mm			
Weight	102g			

Working Distance (mm)	Optical Magnification	Extension Ring (mm)	Field of View(mm)			
			1/2"		1/3"	
			H	V	H	V
900	0.006X	-	1179.8	882.3	882.3	657.2
850	0.006X	-	1115.4	834.2	834.2	621.3
800	0.006X	-	1051.0	786.0	786.0	585.4
750	0.007X	-	986.6	737.8	737.8	549.5
700	0.007X	-	922.3	689.6	689.6	513.6
650	0.008X	-	857.9	641.4	641.4	477.7
600	0.008X	-	793.5	593.2	593.2	441.8
550	0.009X	-	729.1	545.0	545.0	405.9
500	0.010X	-	664.7	496.9	496.9	370.0
450	0.011X	-	600.3	448.7	448.7	334.1
400	0.012X	-	535.9	400.5	400.5	298.2
350	0.014X	-	471.5	352.3	352.3	262.3
300	0.016X	-	407.1	304.1	304.1	226.4
250	0.019X	-	342.7	255.9	255.9	190.5
200	0.024X	-	278.4	207.8	207.8	154.6
150	0.031X	-	214.0	159.6	159.6	118.7
100	0.044X	-	149.6	111.4	111.4	82.8

Field of View = CCD Size / Optical Magnification

M0814-MP2

- 2/3"
- 1.5MP
- FIX
- MANUAL

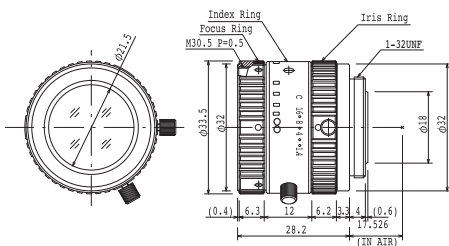

Focal Length	8mm				
Max. Aperture Ratio	1:1.4				
Max. Image Format	8.8mm x 6.6mm (φ 11mm)				
Operation Range	Iris	F1.4 - F16C			
	Focus	0.1m - Inf.			
Control	Iris	Manual			
	Focus	Manual			
Object Dimension at M.O.D.	12.1(H)cm x 9.0(V)cm 2/3"				
Angle of View	D	67.1°	51.9°		
		43.7°	32.4°		
	H	2/3"	56.3°	1/2"	42.5°
		V	43.7°		
Operating Temperature	-10° C ~ +50° C				

Distortion	2/3"	-0.1% (y=5.5)	1/2"	-1.1% (y=4.0)
BackFocal Length	13.1mm (Inf)			
Flange Back Length	17.526mm			
Mount	C-Mount			
Filter Size	M30.5 P=0.5mm			
Dimensions	φ 33.5mm x 28.2mm			
Weight	63g			

Working Distance (mm)	Optical Magnification	Extension Ring (mm)	Field of View(mm)			
			2/3"		1/2"	
			H	V	H	V
900	0.009X	-	976.8	731.5	709.1	530.1
850	0.010X	-	923.3	691.4	670.2	501.0
800	0.010X	-	869.8	651.3	631.4	471.9
750	0.011X	-	816.3	611.2	592.5	442.8
700	0.012X	-	762.8	571.1	553.6	413.8
650	0.013X	-	709.3	531.0	514.7	384.7
600	0.014X	-	655.8	490.9	475.8	355.6
550	0.015X	-	602.3	450.8	437.0	326.5
500	0.016X	-	548.8	410.7	398.1	297.5
450	0.018X	-	495.3	370.6	359.2	268.4
400	0.020X	-	441.8	330.5	320.3	239.3
350	0.023X	-	388.3	290.4	281.4	210.2
300	0.027X	-	334.8	250.3	242.6	181.2
250	0.032X	-	281.2	210.2	203.7	152.1
200	0.039X	-	227.7	170.0	164.8	123.0
150	0.052X	-	174.2	129.9	125.9	93.9
100	0.075X	-	120.7	89.8	87.0	64.9

Field of View = CCD Size / Optical Magnification

M1214-MP2

- 2/3"
- 1.5MP
- FIX
- MANUAL

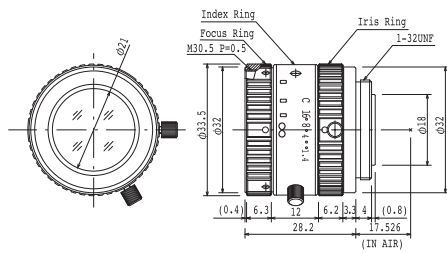

Focal Length	12mm		
Max. Aperture Ratio	1:1.4		
Max. Image Format	8.8mm x 6.6mm (φ11mm)		
Operation Range	Iris	F1.4 - F16C	
	Focus	0.15m - Inf.	
Control	Iris	Manual	
	Focus	Manual	
Object Dimension at M.O.D.	12.1(H)cm x 9.0(V)cm 2/3"		
Angle of View	D	49.2°	37.0°
	H	2/3" 40.4°	1/2" 30.0°
	V	30.8°	22.7°
Operating Temperature	-10° C ~ +50° C		

Distortion	2/3"	-0.1% (y=5.5)	1/2"	-0.35% (y=4.0)
Back Focal Length	13.1mm (Inf)			
Flange Back Length	17.526mm			
Mount	C-Mount			
Filter Size	M30.5 P=0.5mm			
Dimensions	φ 33.5mm x 28.2mm			
Weight	62g			

Working Distance (mm)	Optical Magnification	Extension Ring (mm)	Field of View(mm)			
			2/3"		1/2"	
			H	V	H	V
900	0.013X	-	672.7	504.0	488.7	366.0
850	0.014X	-	635.9	476.4	461.9	345.9
800	0.015X	-	599.1	448.9	435.2	325.9
750	0.016X	-	562.4	421.3	408.4	305.9
700	0.017X	-	525.6	393.7	381.7	285.8
650	0.018X	-	488.8	366.1	355.0	265.8
600	0.020X	-	452.1	338.5	328.2	245.7
550	0.021X	-	415.3	311.0	301.5	225.7
500	0.023X	-	378.5	283.4	274.7	205.7
450	0.026X	-	341.7	255.8	248.0	185.6
400	0.029X	-	305.0	228.2	221.2	165.6
350	0.033X	-	268.2	200.6	194.5	145.6
300	0.038X	-	231.4	173.0	167.7	125.5
250	0.046X	-	194.7	145.5	141.0	105.5
200	0.056X	-	157.9	117.9	114.3	85.4
150	0.074X	-	121.1	90.3	87.5	65.4
100	0.106X	0.5	84.3	62.7	60.8	45.4

Field of View = CCD Size / Optical Magnification

M1614-MP2

- 2/3"
- 1.5MP
- FIX
- MANUAL

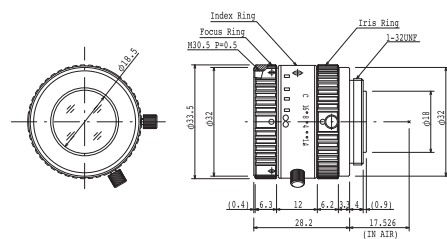

Focal Length	16mm		
Max. Aperture Ratio	1:1.4		
Max. Image Format	8.8mm x 6.6mm (φ11mm)		
Operation Range	Iris	F1.4 - F16C	
	Focus	0.3m - Inf.	
Control	Iris	Manual	
	Focus	Manual	
Object Dimension at M.O.D.	17.2(H)cm x 12.9(V)cm 2/3"		
Angle of View	D	38.0°	28.2°
	H	2/3" 30.8°	1/2" 22.7°
	V	23.4°	17.1°
Operating Temperature	-10° C ~ +50° C		

Distortion	2/3"	-0.1% (y=5.5)	1/2"	-0.3% (y=4.0)
Back Focal Length	13.1mm (Inf)			
Flange Back Length	17.526mm			
Mount	C-Mount			
Filter Size	M30.5 P=0.5mm			
Dimensions	φ 33.5mm x 28.2mm			
Weight	60g			

Working Distance (mm)	Optical Magnification	Extension Ring (mm)	Field of View(mm)			
			2/3"		1/2"	
			H	V	H	V
900	0.018X	-	503.2	376.8	365.4	273.7
850	0.019X	-	475.6	356.2	345.3	258.6
800	0.020X	-	448.0	335.5	325.3	243.6
750	0.021X	-	420.4	314.8	305.2	228.6
700	0.023X	-	392.8	294.1	285.2	213.6
650	0.024X	-	365.2	273.4	265.1	198.5
600	0.026X	-	337.6	252.8	245.1	183.5
550	0.029X	-	310.0	232.1	225.0	168.5
500	0.031X	-	282.5	211.4	204.9	153.5
450	0.035X	-	254.9	190.7	184.9	138.4
400	0.039X	-	227.3	170.0	164.8	123.4
350	0.044X	-	199.7	149.4	144.8	108.4
300	0.052X	-	172.1	128.7	124.7	93.4
250	0.061X	-	144.5	108.0	104.7	78.3
200	0.076X	-	116.9	87.3	84.6	63.3
150	0.100X	0.5	89.3	66.6	64.6	48.3
100	0.145X	1.0	61.7	45.9	44.5	33.2

Field of View = CCD Size / Optical Magnification

C-MOUNT
2/3" 1.5MP

MEGAPIXEL LENS

MACHINE VISION LENS

M2514-MP2

- 2/3"
- 1.5MP
- FIX
- MANUAL

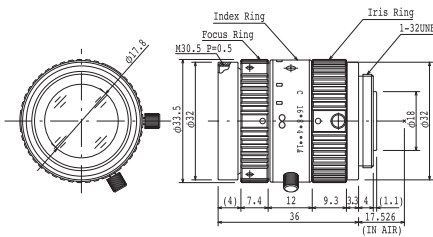

Focal Length	25mm		
Max. Aperture Ratio	1:1.4		
Max. Image Format	8.8mm x 6.6mm (φ11mm)		
Operation Range	Iris	F1.4 - F16C	
	Focus	0.3m - Inf.	
Control	Iris	Manual	
	Focus	Manual	
Object Dimension at M.O.D.	10.6(H)cm x 7.9(V)cm 2/3"		
Angle of View	D	2/3"	18.2°
		1/2"	14.6°
	V	15.1°	11.0°
Operating Temperature	-10°C ~ +50°C		

Distortion	2/3"	-0.3% (y=5.5)	1/2"	-0.1% (y=4.0)
BackFocal Length	13.1mm (Inf)			
Flange Back Length	17.526mm			
Mount	C-Mount			
Filter Size	M30.5 P=0.5mm			
Dimensions	φ 33.5mm x 36.0mm			
Weight	71g			

Working Distance (mm)	Optical Magnification	Extension Ring (mm)	Field of View(mm)			
			2/3"		1/2"	
			H	V	H	V
900	0.028X	-	317.5	237.7	230.5	172.7
850	0.029X	-	299.9	224.5	217.7	163.1
800	0.031X	-	282.3	211.3	204.8	153.5
750	0.033X	-	264.6	198.1	192.0	143.9
700	0.036X	-	247.0	184.9	179.2	134.3
650	0.039X	-	229.4	171.6	166.4	124.7
600	0.042X	-	211.8	158.4	153.6	115.1
550	0.046X	-	194.1	145.2	140.8	105.5
500	0.050X	-	176.5	132.0	128.0	95.9
450	0.056X	-	158.9	118.8	115.2	86.3
400	0.063X	-	141.2	105.6	102.4	76.7
350	0.072X	-	123.6	92.4	89.6	67.1
300	0.084X	-	106.0	79.2	76.8	57.5
250	0.100X	-	88.3	66.0	63.9	47.9
200	0.126X	-	70.7	52.7	51.1	38.3
150	0.168X	-	53.0	39.5	38.3	28.7
100	0.253X	1.5	35.3	26.3	25.5	19.0

Field of View = CCD Size / Optical Magnification

M3514-MP

- 2/3"
- 1.5MP
- FIX
- MANUAL

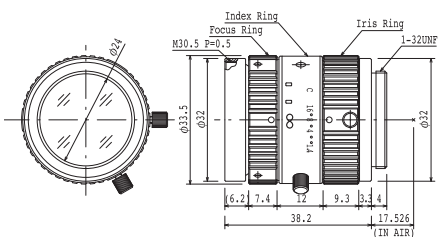

Focal Length	35mm		
Max. Aperture Ratio	1:1.4		
Max. Image Format	8.8mm x 6.6mm (φ11mm)		
Operation Range	Iris	F1.4 - F16C	
	Focus	0.3m - Inf.	
Control	Iris	Manual	
	Focus	Manual	
Object Dimension at M.O.D.	8.1(H)cm x 6(V)cm 2/3"		
Angle of View	D	2/3"	12.6°
		1/2"	10.1°
	V	10.4°	7.6°
Operating Temperature	-10°C ~ +50°C		

Distortion	2/3"	-0.8% (y=5.5)	1/2"	-0.4% (y=4.0)
BackFocal Length	17.1mm (WD=400mm)			
Flange Back Length	17.526mm			
Mount	C-Mount			
Filter Size	M30.5 P=0.5mm			
Dimensions	φ 33.5mm x 38.2mm			
Weight	87g			

Working Distance (mm)	Optical Magnification	Extension Ring (mm)	Field of View(mm)			
			2/3"		1/2"	
			H	V	H	V
900	0.037	-	236.2	176.9	171.5	128.6
850	0.040	-	223.2	167.2	162.1	121.5
800	0.042	-	210.3	157.5	152.7	114.5
750	0.045	-	197.3	147.8	143.3	107.4
700	0.048	-	184.3	138.1	133.9	100.3
650	0.052	-	171.4	128.4	124.5	93.3
600	0.056	-	158.4	118.6	115.0	86.2
550	0.061	-	145.5	108.9	105.6	79.1
500	0.067	-	132.5	99.2	96.2	72.1
450	0.074	-	119.6	89.5	86.8	65.0
400	0.083	-	106.6	79.8	77.4	58.0
350	0.094	-	93.7	70.1	67.9	50.9
300	0.110	-	80.7	60.4	58.5	43.8
250	0.131	1	67.7	50.6	49.1	36.8
200	0.162	2	54.7	40.9	39.7	29.7
150	0.213	5	41.8	31.2	30.2	22.6
100	0.310	7	28.7	21.4	20.8	15.5

Field of View = CCD Size / Optical Magnification

M5018-MP2

- 2/3"
- 1.5MP
- FIX
- MANUAL

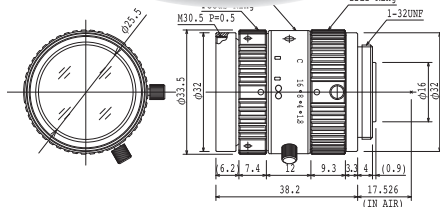

Focal Length	50mm		
Max. Aperture Ratio	1:1.8		
Max. Image Format	8.8mm x 6.6mm (φ11mm)		
Operation Range	Iris	F1.8 - F16C	
	Focus	0.5m - Inf.	
Control	Iris	Manual	
	Focus	Manual	
Object Dimension at M.O.D.	8.7(H)cm x 6.5(V)cm 2/3"		
Angle of View	D	13.1°	9.5°
	H	2/3" 10.5°	1/2" 7.6°
	V	7.9°	5.7°
Operating Temperature	-10° C ~ +50° C		

Distortion	2/3" -0.3% (y=5.5)	1/2" -0.2% (y=4.0)
BackFocal Length	13.1mm (Inf)	
Flange Back Length	17.526mm	
Mount	C-Mount	
Filter Size	M30.5 P=0.5mm	
Dimensions	φ 33.5mm x 38.2mm	
Weight	85g	

Working Distance (mm)	Optical Magnification	Extension Ring (mm)	Field of View(mm)			
			2/3"		1/2"	
			H	V	H	V
900	0.055X	-	160.8	120.4	116.7	87.5
850	0.058X	-	151.6	113.5	110.1	82.5
800	0.062X	-	142.4	106.6	103.4	77.5
750	0.066X	-	133.2	99.7	96.7	72.5
700	0.071X	-	124.0	92.9	90.0	67.5
650	0.077X	-	114.8	86.0	83.4	62.5
600	0.084X	-	105.6	79.1	76.7	57.5
550	0.092X	-	96.5	72.2	70.1	52.5
500	0.101X	-	87.3	65.3	63.3	47.5
450	0.113X	0.5	78.1	58.4	56.7	42.5
400	0.128X	1.5	68.9	51.6	50.0	37.5
350	0.148X	2.5	59.7	44.7	43.3	32.5
300	0.175X	3.5	50.5	37.8	36.6	27.4
250	0.214X	5.5	41.3	30.9	30.0	22.4
200	0.276X	8.5	32.1	24.0	23.3	17.4
150	0.387X	14.0	22.9	17.1	16.6	12.4
100	0.647X	26.5	13.6	10.2	9.9	7.4

Field of View = CCD Size / Optical Magnification

M7528-MP

- 2/3"
- 1.5MP
- FIX
- MANUAL
- TELE

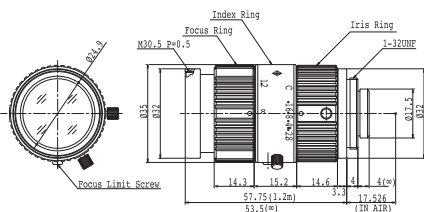

Focal Length	75mm		
Max. Aperture Ratio	1:2.8		
Max. Image Format	8.8mm x 6.6mm (φ11mm)		
Operation Range	Iris	F2.8 - F16C	
	Focus	0.3m - Inf. (※)	
Control	Iris	Manual	
	Focus	Manual	
Object Dimension at M.O.D.	4.1(H)cm x 3.1(V)cm 2/3"		
Angle of View	D	8.5°	6.2°
	H	2/3" 6.8°	1/2" 5°
	V	5.1°	3.7°
Operating Temperature	-10° C ~ +50° C		

Distortion	2/3" -0.4% (y=5.5)	1/2" -0.2% (y=4.0)
BackFocal Length	21.5mm (WD=400mm)	
Flange Back Length	17.526mm	
Mount	C-Mount	
Filter Size	M30.5 P=0.5mm	
Dimensions	φ 35mm x 57.75mm	
Weight	113g	

※ Factory setting is 0.3-1.2m. Focus can be adjusted to infinity by removing "Focus Limit Screw".

Working Distance (mm)	Optical Magnification	Extension Ring (mm)	Field of View(mm)			
			2/3"		1/2"	
			H	V	H	V
900	0.077	-	113.8	85.4	82.8	62.1
850	0.082	-	107.8	80.8	78.4	58.8
800	0.086	-	101.7	76.3	74.0	55.5
750	0.092	-	95.7	71.8	69.6	52.2
700	0.098	-	89.6	67.2	65.2	48.9
650	0.105	-	83.6	62.7	60.8	45.6
600	0.114	-	77.6	58.1	56.4	42.3
550	0.123	-	71.5	53.6	52.0	39.0
500	0.135	-	65.5	49.1	47.6	35.7
450	0.148	-	59.4	44.5	43.2	32.4
400	0.165	-	53.4	40.0	38.8	29.1
350	0.187	-	47.3	35.4	34.4	25.8
300	0.214	-	41.3	30.9	30.0	22.5
250	0.251	5	35.2	26.4	25.6	19.1
200	0.304	7	29.2	21.8	21.2	15.8
150	0.384	13	23.1	17.3	16.8	12.5
100	0.522	23	17.1	12.7	12.3	9.2

Field of View = CCD Size / Optical Magnification

C-MOUNT
2/3" 5MP

5 MEGAPIXEL ULTRA LOW DISTORTION LENS

MACHINE VISION LENS

- Ultra low distortion (optical distortion 0.1% or less)
- Higher relative illumination rate
- Compact design

- Locking set screws for focus and iris

M0824-MPW2

2/3"

5MP

FIX

MANUAL



Focal Length	8mm	
Max. Aperture Ratio	1:2.4	
Max. Image Format	8.8mm x 6.6mm (φ 11mm)	
Operation Range	Iris	F2.4 - F16.0
	Focus	0.05m - Inf.
Control	Iris	Manual
	Focus	Manual
Object Dimension at M.O.D.	5.4cm x 7.4cm 2/3"	
Angle of View	D	69.32°
	H	57.80°
	V	44.36°

Distortion	2/3" 1.87%(y=5.5)	1/1.8" -1.55%(y=4.32)	1/2" -1.42%(y=4.0)
Back Focal Length	13.7mm(WD=300mm)		
Flange Back Length	17.526mm		
Mount	C-Mount		
Filter Size	M30.5 P=0.5mm		
Dimensions	φ 32mm x 45.71 mm		
Weight	80g		

Working Distance (mm)	Optical Magnification	Extension Ring (mm)	Field of View(mm)					
			2/3"		1/1.8"		1/2"	
			H	V	H	V	H	V
900	-0.009	-	1011.1	755.4	791.6	591.5	732.2	547.3
850	-0.009	-	956.0	714.2	748.5	559.3	692.3	517.4
800	-0.010	-	900.9	673.0	705.3	527.0	652.3	487.6
750	-0.011	-	845.8	631.8	662.1	494.7	612.4	457.7
700	-0.011	-	790.7	590.6	618.9	462.5	572.5	427.8
650	-0.012	-	735.6	549.4	575.8	430.2	532.5	398.0
600	-0.013	-	680.4	508.2	532.6	397.9	492.6	368.1
550	-0.014	-	625.3	467.0	489.4	365.6	452.6	338.3
500	-0.016	-	570.0	425.6	446.0	333.2	412.6	308.2
450	-0.017	-	515.0	384.4	403.0	301.0	372.6	278.4
400	-0.019	-	459.8	343.2	359.8	268.8	332.6	248.6
350	-0.022	-	404.6	302.0	316.6	236.4	292.8	218.8
300	-0.026	-	349.6	260.8	273.4	204.2	252.8	188.8
250	-0.030	-	294.4	219.6	230.2	171.8	212.8	159.0
200	-0.037	-	239.4	178.4	187.0	139.6	173.0	129.2
150	-0.049	-	184.2	137.2	143.8	107.4	133.0	99.2
100	-0.070	-	129.0	96.0	100.6	75.0	93.0	69.4
50	-0.127	-	71.4	52.9	55.5	41.3	51.3	38.2

Field of View = CCD Size / Optical Magnification

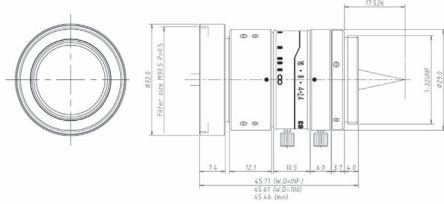

M1224-MPW2

2/3"

5MP

FIX

MANUAL



Focal Length	12mm	
Max. Aperture Ratio	1:2.4	
Max. Image Format	8.8mm x 6.6mm (φ 11mm)	
Operation Range	Iris	F2.4 - F16.0
	Focus	0.1m - Inf.
Control	Iris	Manual
	Focus	Manual
Object Dimension at M.O.D.	6.4cm x 8.5cm 2/3"	
Angle of View	D	48.6°
	H	39.8°
	V	30.4°

Distortion	2/3" -0.05%(y=5.5)	1/1.8" -0.34%(y=4.32)	1/2" -0.35%(y=4.0)
Back Focal Length	14.4mm(WD=300mm)		
Flange Back Length	17.526mm		
Mount	C-Mount		
Filter Size	M27.0 P=0.5mm		
Dimensions	φ 29mm x 42.68mm		
Weight	72g		

Working Distance (mm)	Optical Magnification	Extension Ring (mm)	Field of View(mm)					
			2/3"		1/1.8"		1/2"	
			H	V	H	V	H	V
900	-0.0131	-	671.2	503.7	527.5	395.5	488.4	366.1
850	-0.0138	-	634.6	476.2	498.7	373.9	461.8	346.1
800	-0.0147	-	598.0	448.7	469.9	352.3	435.1	326.1
750	-0.0157	-	561.4	421.2	441.1	330.7	408.4	306.1
700	-0.016	-	524.7	393.7	412.3	309.1	381.8	286.1
650	-0.018	-	488.1	366.2	383.5	287.5	355.1	266.1
600	-0.019	-	451.5	338.7	354.7	265.9	328.4	246.1
550	-0.021	-	414.8	311.2	325.9	244.3	301.7	226.1
500	-0.022	-	378.2	283.7	297.2	222.7	275.1	206.2
450	-0.026	-	341.6	256.2	268.4	201.1	248.4	186.2
400	-0.029	-	305.0	228.7	239.6	179.5	221.8	166.2
350	-0.033	-	268.3	201.2	210.8	157.9	195.1	146.2
300	-0.038	-	231.7	173.7	182.0	136.3	168.4	126.2
250	-0.045	-	195.1	146.2	153.2	114.7	141.8	106.2
200	-0.056	-	158.5	118.7	124.4	93.1	115.1	86.2
150	-0.073	-	121.8	91.2	95.6	71.5	88.4	66.2
100	-0.104	-	85.2	63.7	66.8	50.0	61.8	46.2

Field of View = CCD Size / Optical Magnification

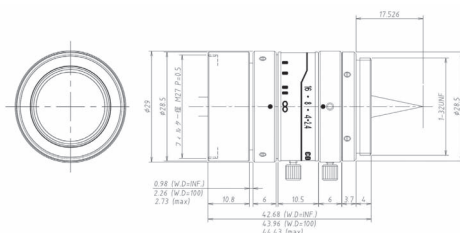

M1620-MPW2

- 2/3"
- 5MP
- FIX
- MANUAL

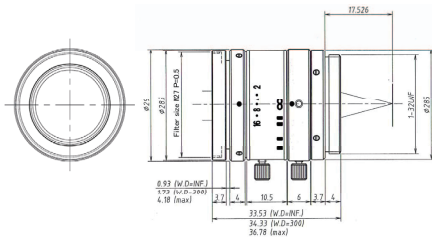

Focal Length	16mm	
Max. Aperture Ratio	1:2.0	
Max. Image Format	8.8mm x 6.6mm (φ 11mm)	
Operation Range	Iris	F2.0 - F16.0
	Focus	0.2m - Inf.
Control	Iris	Manual
	Focus	Manual
Object Dimension at M.O.D.	8.8cm x 11.74cm 2/3"	
Angle of View	D	37.7°
	H	30.7°
	V	23.3°

Distortion	2/3" 0.09%(y=5.5)	1/1.8" -0.06%(y=4.32)	1/2" -0.07%(y=4.0)
Back Focal Length	14.7mm (WD=300mm)		
Flange Back Length	17.526mm		
Mount	C-Mount		
Filter Size	M27.0 P=0.5mm		
Dimensions	φ 29mm x 33.53mm		
Weight	53g		

Working Distance (mm)	Optical Magnification	Extension Ring (mm)	Field of View(mm)					
			2/3"		1/1.8"		1/2"	
			H	V	H	V	H	V
900	-0.018	-	501.2	376.4	393.5	296.7	365.0	273.9
850	-0.019	-	473.8	355.8	372.0	280.5	345.1	258.9
800	-0.020	-	446.4	335.2	350.4	264.2	325.1	243.9
750	-0.021	-	418.9	314.6	328.9	248.0	305.1	228.9
700	-0.022	-	391.5	294.0	307.4	231.7	285.1	213.9
650	-0.024	-	364.1	273.4	285.8	215.5	265.2	198.9
600	-0.026	-	336.7	252.8	264.3	199.3	245.2	183.9
550	-0.028	-	309.3	232.2	242.8	183.0	225.2	168.9
500	-0.031	-	281.9	211.6	221.2	166.8	205.2	153.9
450	-0.035	-	254.5	191.0	199.7	150.5	185.2	138.9
400	-0.039	-	227.1	170.4	178.2	134.3	165.3	124.0
350	-0.044	-	199.7	149.8	156.6	118.0	145.3	109.0
300	-0.0511	-	172.2	129.2	135.1	101.8	125.3	94.0
250	-0.061	-	144.8	108.6	113.6	85.6	105.1	79.2
200	-0.075	-	117.4	88.0	92.0	69.3	85.3	64.0
150	-0.098	0.5	90.0	67.4	70.5	53.1	65.3	49.0
100	-0.142	1	62.5	46.8	48.9	36.8	45.4	34.0

Field of View = CCD Size / Optical Magnification

M2518-MPW2

- 2/3"
- 5MP
- FIX
- MANUAL

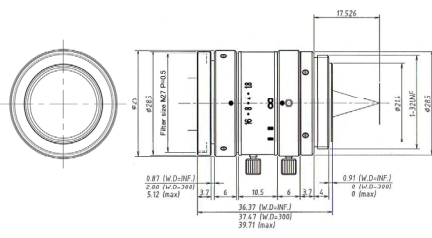

Focal Length	25mm	
Max. Aperture Ratio	1:1.8	
Max. Image Format	8.8mm x 6.6mm (φ 11mm)	
Operation Range	Iris	F1.8 - F16.0
	Focus	0.2m - Inf.
Control	Iris	Manual
	Focus	Manual
Object Dimension at M.O.D.	5.48cm x 7.31cm 2/3"	
Angle of View	D	24.6°
	H	19.9°
	V	15.0°

Distortion	2/3" 0.03%(y=5.5)	1/1.8" -0.02%(y=4.32)	1/2" -0.02%(y=4.0)
Back Focal Length	13.8mm (WD=300mm)		
Flange Back Length	17.526mm		
Mount	C-Mount		
Filter Size	M27.0 P=0.5mm		
Dimensions	φ 29mm x 36.37mm		
Weight	60g		

Working Distance (mm)	Optical Magnification	Extension Ring (mm)	Field of View(mm)					
			2/3"		1/1.8"		1/2"	
			H	V	H	V	H	V
900	-0.028	-	318.2	238.9	249.8	188.4	231.7	173.9
850	-0.029	-	300.7	225.8	236.0	178.0	219.0	164.3
800	-0.031	-	283.2	212.6	222.3	167.6	206.2	154.7
750	-0.033	-	265.7	199.5	208.5	157.2	193.5	145.2
700	-0.035	-	248.2	186.3	194.8	146.9	180.7	135.6
650	-0.038	-	230.7	173.2	181.0	136.5	168.0	126.0
600	-0.041	-	213.2	160.0	167.3	126.1	155.2	116.4
550	-0.045	-	195.7	146.9	153.6	115.8	142.5	106.9
500	-0.049	-	178.2	133.7	139.8	105.4	129.7	97.3
450	-0.055	-	160.7	120.6	126.1	95.0	116.9	87.7
400	-0.061	-	143.2	107.4	112.3	84.7	104.2	78.1
350	-0.070	-	125.7	94.3	98.6	74.3	91.4	68.6
300	-0.081	-	108.2	81.1	84.8	63.9	78.7	59.0
250	-0.097	-	90.7	68.0	71.1	53.5	65.9	49.4
200	-0.121	-	73.1	54.8	57.3	43.2	53.1	39.8
150	-0.159	1	55.6	41.6	43.5	32.8	40.4	30.3
100	-0.233	5	38.0	28.5	29.8	22.4	27.6	20.7

Field of View = CCD Size / Optical Magnification

C-MOUNT
2/3" 5MP

5 MEGAPIXEL ULTRA LOW DISTORTION LENS

MACHINE VISION LENS

- Ultra low distortion (optical distortion 0.1% or less)
- Higher relative illumination rate

- Compact design
- Locking set screws for focus and iris

M3520-MPW2

- 2/3"
- 5MP
- FIX
- MANUAL

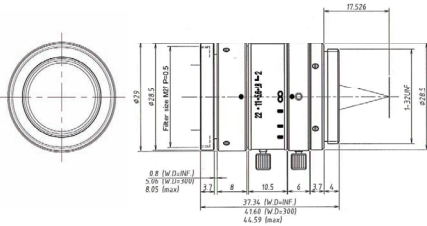

Focal Length	35mm			
Max. Aperture Ratio	1:2.0			
Max. Image Format	8.8mm x 6.6mm (φ 11mm)			
Operation Range	Iris	F2.0 - F22.0		
	Focus	0.2m - Inf.		
Control	Iris	Manual		
	Focus	Manual		
Object Dimension at MOD.	3.48cm x 4.63cm 2/3"			
Angle of View	D	17.8°	14.0°	13.0°
	H	2/3" 14.3°	1/1.8" 11.2°	1/2" 10.4°
	V	10.7°	8.5°	7.8°
Operating Temperature	-10° C ~ +50° C			

Distortion	2/3" 0.011%(y)=-5.5)	1/1.8" 0.010%(y)=-4.32)	1/2" 0.009%(y)=-4.0)
BackFocal Length	18.0mm (WD=300mm)		
FlangeBack Length	17.526mm		
Mount	C-Mount		
Filter Size	M27.0 P=0.5mm		
Dimensions	φ 29mm x 37.34mm		
Weight	59g		

Working Distance (mm)	Optical Magnification	Extension Ring (mm)	Field of View(mm)					
			2/3"		1/1.8"		1/2"	
			H	V	H	V	H	V
900	-0.040	-	221.8	166.4	174.0	131.2	161.4	121.1
850	-0.042	-	209.3	157.0	164.2	123.8	152.3	114.2
800	-0.045	-	196.7	147.6	154.3	116.3	143.2	107.4
750	-0.048	-	184.2	138.2	144.5	108.9	134.0	100.6
700	-0.051	-	171.7	128.8	134.7	101.5	124.9	93.7
650	-0.055	-	159.2	119.4	124.8	94.1	115.8	86.9
600	-0.060	-	146.6	110.0	115.0	98.7	106.7	80.0
550	-0.066	-	134.1	100.6	105.2	79.3	97.6	73.2
500	-0.072	-	121.6	91.2	95.3	71.9	88.4	66.3
450	-0.081	-	109.0	81.8	85.5	64.5	79.3	59.5
400	-0.091	-	96.5	72.4	75.7	57.0	70.2	52.7
350	-0.105	-	84.0	63.0	65.8	49.6	61.1	45.8
300	-0.123	-	71.4	53.6	56.0	42.2	52.0	39.0
250	-0.150	-	58.9	44.2	46.2	34.8	42.8	32.1
200	-0.190	-	46.3	34.8	36.3	27.4	33.7	25.3
150	-0.261	5	33.8	25.3	26.5	20.0	24.6	18.4
100	-0.417	10	21.2	15.9	16.6	12.5	15.4	11.5

Field of View = CCD Size / Optical Magnification

M5028-MPW2

- 2/3"
- 5MP
- FIX
- MANUAL

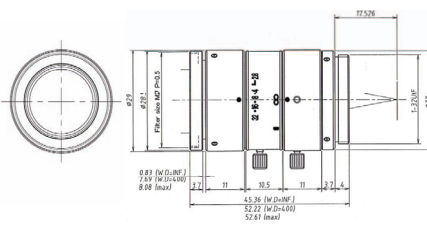

Focal Length	50mm			
Max. Aperture Ratio	1:2.8			
Max. Image Format	8.8mm x 6.6mm (φ 11mm)			
Operation Range	Iris	F2.8 - F32.0		
	Focus	0.4m - Inf.		
Control	Iris	Manual		
	Focus	Manual		
Object Dimension at MOD.	4.78cm x 6.38cm 2/3"			
Angle of View	D	12.5°	9.9°	9.1°
	H	2/3" 10.0°	1/1.8" 7.9°	1/2" 7.3°
	V	7.5°	5.9°	5.5°
Operating Temperature	-10° C ~ +50° C			

Distortion	2/3" 0.027%(y)=-5.5)	1/1.8" 0.017%(y)=-4.32)	1/2" 0.015%(y)=-4.0)
BackFocal Length	27.7mm (WD=400mm)		
FlangeBack Length	17.526mm		
Mount	C-Mount		
Filter Size	M27.0 P=0.5mm		
Dimensions	φ 29mm x 45.36mm		
Weight	69g		

Working Distance (mm)	Optical Magnification	Extension Ring (mm)	Field of View(mm)					
			2/3"		1/1.8"		1/2"	
			H	V	H	V	H	V
900	-0.058	-	151.7	113.8	118.9	89.6	110.3	82.7
850	-0.062	-	142.9	107.2	112.0	84.4	103.9	77.9
800	-0.066	-	134.1	100.6	105.1	79.2	97.5	73.1
750	-0.070	-	125.3	94.0	98.2	74.0	91.1	68.3
700	-0.075	-	116.5	87.4	91.3	68.9	84.7	63.6
650	-0.082	-	107.7	80.8	84.5	63.7	78.3	58.8
600	-0.089	-	98.9	74.2	77.6	58.5	71.9	54.0
550	-0.098	-	90.1	67.6	70.7	53.3	65.6	49.2
500	-0.108	-	81.3	61.0	63.8	48.1	59.2	44.4
450	-0.121	-	72.6	54.4	56.9	42.9	52.8	39.6
400	-0.138	-	63.8	47.8	50.0	37.7	46.4	34.8
350	-0.160	1	55.0	41.2	43.1	32.5	40.0	30.0
300	-0.191	5	46.2	34.6	36.2	27.3	33.6	25.2
250	-0.235	5	37.4	28.1	29.3	22.1	27.2	20.4
200	-0.308	10	28.6	21.5	22.4	16.9	20.8	15.6
150	-0.445	20	19.8	14.9	15.5	11.7	14.4	10.8
100	-0.801	40	11.0	8.2	8.6	6.5	8.0	6.0

Field of View = CCD Size / Optical Magnification

M2518-MPW

- 2/3"
- 5MP
- FIX
- MANUAL
- FLOATING

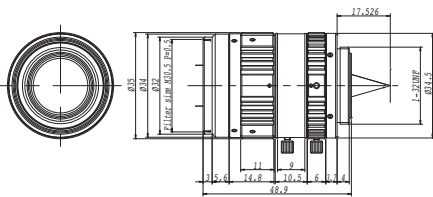

Focal Length	25mm	
Max. Aperture Ratio	1:1.8	
Max. Image Format	8.8mm x 6.6mm (φ 11mm)	
Operation Range	Iris	F1.8 - F16.0
	Focus	0.15m - Inf.
Control	Iris	Manual
	Focus	Manual
Object Dimension at M.O.D.	4.10cm x 5.48cm 2/3"	
Angle of View	D	25.4°
	H	20.5°
	V	15.4°

Distortion	2/3" 0.03%(y=5.5)	1/1.8" -0.02%(y=4.32)	1/2" -0.02%(y=4.0)
Back Focal Length	14.0mm (WD=300mm)		
Flange Back Length	17.526mm		
Mount	C-Mount		
Filter Size	M30.5 P=0.5mm		
Dimensions	φ 35mm x 48.90mm		
Weight	102g		

Working Distance (mm)	Optical Magnification	Extension Ring (mm)	Field of View(mm)					
			2/3"		1/1.8"		1/2"	
			H	V	H	V	H	V
900	-0.027	-	325.4	243.4	254.5	191.9	236.1	177.1
850	-0.029	-	306.2	229.9	240.3	181.2	222.9	167.3
800	-0.030	-	288.2	216.3	226.1	170.5	209.8	157.4
750	-0.033	-	270.2	202.8	212.0	159.8	196.7	147.5
700	-0.035	-	252.1	189.3	197.8	149.2	183.5	137.7
650	-0.038	-	234.1	175.7	183.7	138.5	170.4	127.8
600	-0.041	-	216.1	162.2	169.5	127.8	157.3	118.0
550	-0.044	-	198.1	148.7	155.4	117.1	144.2	108.1
500	-0.049	-	180.1	135.1	141.3	106.5	131.0	98.3
450	-0.054	-	162.1	121.6	127.1	95.8	117.9	88.5
400	-0.061	-	144.1	108.1	113.0	85.2	104.8	78.6
350	-0.070	-	126.1	94.6	98.9	74.5	91.7	68.8
300	-0.081	-	108.2	81.1	84.8	63.9	78.7	59.0
250	-0.098	-	90.3	67.7	70.8	53.3	65.6	49.2
200	-0.122	-	72.4	54.3	56.8	42.8	52.6	39.5
150	-0.161	-	54.8	41.0	42.9	32.3	39.8	29.8
100	-0.236	5	37.5	28.1	29.4	22.1	27.2	20.4

Field of View = CCD Size / Optical Magnification

FLOATING

Basically, lens is designed to show the best performance at a certain working distance. Due to this design, a curvature of field* is caused at other working distances, and the picture deteriorates at the corners. This curvature of field is able to be modified by a method called Floating, which makes several lens element groups move differently and controls aberration. It can provide stable picture quality from short object distances to infinity.

*Curvature of field: Phenomenon caused by the gap of the focal point between center and corner

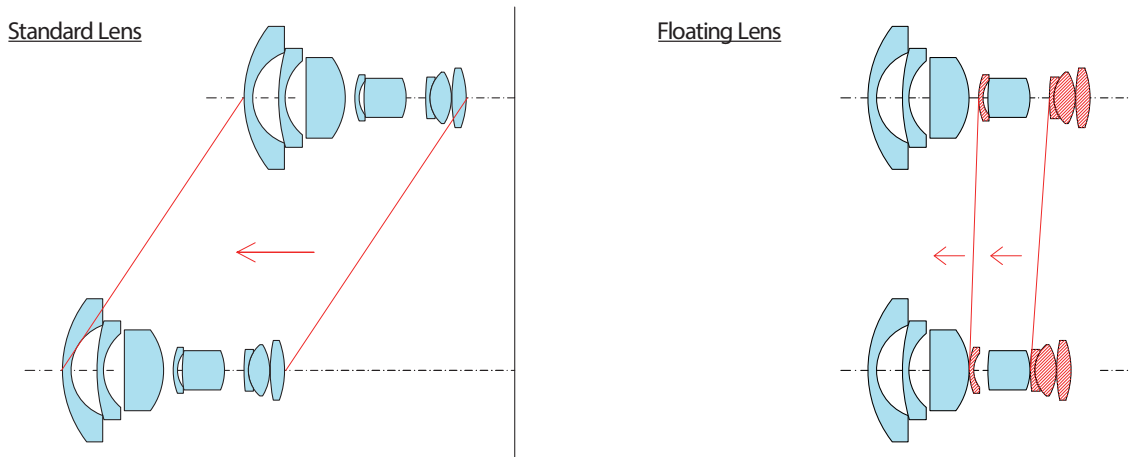

C-MOUNT
1.1" 12MP

1.1" 12 MEGAPIXEL C-MOUNT LENS

MACHINE VISION LENS

- 8, 12, 16, 25, 35, 50mm. 6 Lens Series
- Compatible with 1.1" (φ 17.6mm) Large Format Sensor

- Ultra-High Resolution 12MP
- Compact 1.1" Design (smallest 12MP lens in the industry)

NEW

V0828-MPY

- 1.1"
- 12MP
- FIX
- MANUAL
- FLOATING



Focal Length	8mm		
Max. Aperture Ratio	1:2.8		
Max. Image Format	14.2mm x 10.4mm (φ 17.6mm)		
Operation Range	Iris	F2.8 - F16.0	
	Focus	0.2m - Inf.	
Control	Iris	Manual	
	Focus	Manual	
Object Dimension at M.O.D.	375.6(H)mm x 273.3(V)mm 1.1"		
Angle of View	D	93.9°	89.3°
	H	1.1" 83.0°	1" 77.3°
	V	66.0°	61.7°
Operating Temperature	-10°C ~ +50°C		

Distortion	1.1" -0.6%(γ=8.8)	1" -1.7%(γ=8.0)	2/3" -2.8%(γ=5.5)
Back Focal Length	8.6mm		
Flange Back Length	17.526mm		
Mount	C-Mount		
Filter Size	M72 P=0.75mm (with VM0811)*		
	M67 P=0.75mm (with VM0810)*		
Dimensions	φ 75mm x 54mm		
Weight	155g		

*There is no filter mount on the top of the lens.
For using filters, please attach either VM0811 or VM0810.
For more detail, please refer to P22.

Working Distance (mm)	Optical Magnification	Extension Ring (mm)	Field of View(mm)					
			1.1"		1"		2/3"	
			H	V	H	V	H	V
1000	0.008	-	1790.8	1310.2	1617.6	1206.7	1103.1	820.5
950	0.009	-	1702.4	1245.4	1537.7	1147.0	1048.6	780.0
900	0.009	-	1614.2	1180.9	1458.0	1087.5	994.2	739.5
850	0.010	-	1525.9	1116.2	1378.2	1027.9	939.7	699.0
800	0.010	-	1437.5	1051.4	1298.3	968.3	885.2	658.4
750	0.011	-	1348.8	986.4	1218.0	908.3	830.4	617.6
700	0.012	-	1260.1	921.4	1137.9	848.5	775.7	576.9
650	0.013	-	1172.0	856.8	1058.2	789.0	721.3	536.5
600	0.014	-	1083.5	792.0	978.3	729.3	666.7	495.9
550	0.015	-	995.2	727.3	898.5	669.7	612.2	455.3
500	0.016	-	906.4	662.2	818.2	609.8	557.4	414.6
450	0.018	-	817.8	597.3	738.1	550.0	502.8	373.9
400	0.020	-	729.5	532.6	658.3	490.4	448.3	333.3
350	0.023	-	641.0	467.7	578.3	430.7	393.6	292.7
300	0.027	-	552.1	402.6	497.9	370.6	338.8	251.9
250	0.032	-	463.7	337.9	418.0	311.0	284.3	211.3
200	0.039	-	375.6	273.3	338.4	251.6	229.9	170.9
150	0.051	0.2	287.1	208.5	258.4	191.9	175.3	130.3
100	0.075	0.2	198.5	143.7	178.4	132.2	120.8	89.7

Field of View = CCD Size / Optical Magnification

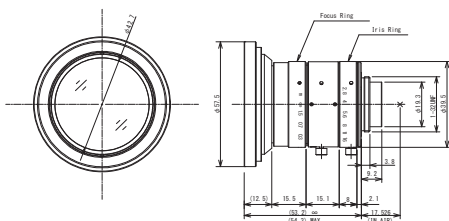

NEW

V1228-MPY

- 1.1"
- 12MP
- FIX
- MANUAL
- FLOATING



Focal Length	12mm		
Max. Aperture Ratio	1:2.8		
Max. Image Format	14.2mm x 10.4mm (φ 17.6mm)		
Operation Range	Iris	F2.8 - F16.0	
	Focus	0.3m - Inf.	
Control	Iris	Manual	
	Focus	Manual	
Object Dimension at M.O.D.	351.6(H)mm x 257.0(V)mm 1.1"		
Angle of View	D	71.1°	66.4°
	H	1.1" 60.5°	1" 55.5°
	V	46.2°	42.9°
Operating Temperature	-10°C ~ +50°C		

Distortion	1.1" -0.5%(γ=8.8)	1" -1.0%(γ=8.0)	2/3" -1.4%(γ=5.5)
Back Focal Length	8.4mm		
Flange Back Length	17.526mm		
Mount	C-Mount		
Filter Size	M40.5 P=0.5mm		
Dimensions	φ 42.0mm x 36.1mm		
Weight	98g		

Working Distance (mm)	Optical Magnification	Extension Ring (mm)	Field of View(mm)					
			1.1"		1"		2/3"	
			H	V	H	V	H	V
1000	0.012	-	1167.9	854.2	1053.4	787.5	720.9	538.6
950	0.013	-	1109.5	811.4	1000.7	748.1	684.8	511.6
900	0.014	-	1051.2	768.8	948.2	708.8	648.9	484.8
850	0.015	-	992.9	726.1	895.5	669.4	612.8	457.8
800	0.015	-	934.6	683.4	842.9	630.1	576.8	430.9
750	0.016	-	876.4	640.9	790.4	590.9	540.9	404.1
700	0.018	-	818.0	598.1	737.7	551.5	504.8	377.1
650	0.019	-	759.7	555.5	685.1	512.2	468.8	350.3
600	0.021	-	701.5	512.9	632.7	472.9	432.9	323.4
550	0.022	-	643.0	470.2	579.9	433.5	396.8	296.5
500	0.025	-	584.7	427.5	527.3	394.2	360.8	269.6
450	0.027	-	526.5	384.9	474.8	354.9	324.9	242.7
400	0.031	-	468.2	342.3	422.2	315.6	288.9	215.8
350	0.035	-	409.9	299.7	369.6	276.3	252.9	189.0
300	0.041	-	351.6	257.0	317.0	237.0	216.9	162.1
250	0.048	0.5	303.1	221.0	273.0	203.7	186.4	139.2
200	0.060	0.5	242.7	177.0	218.6	163.1	149.3	111.5
150	0.079	0.5	182.5	133.1	164.3	122.6	112.2	83.8
100	0.115	1.0	126.3	91.9	113.6	84.7	77.5	57.8

Field of View = CCD Size / Optical Magnification

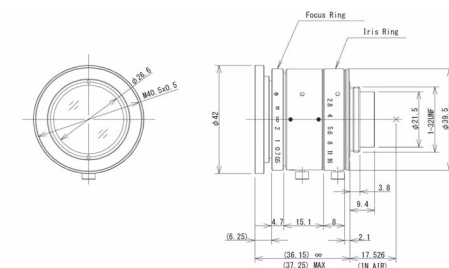

NEW

V1628-MPY

- 1.1"
- 12MP
- FIX
- MANUAL
- FLOATING

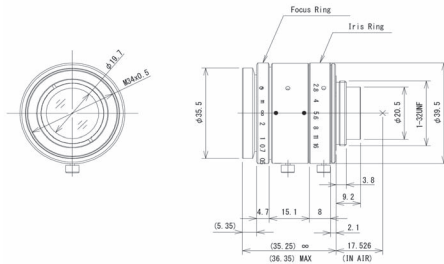

Focal Length	16mm			
Max. Aperture Ratio	1:2.8			
Max. Image Format	14.2mm x 10.4mm (φ 17.6mm)			
Operation Range	Iris F2.8 - F16.0			
	Focus 0.3m - Inf.			
Control	Iris Manual			
	Focus Manual			
Object Dimension at M.O.D.	264.6(H)mm x 193.8(V)mm 1.1"			
Angle of View	D	57.9°	53.4°	38.2°
	H	1.1" 48.2°	1" 43.9°	2/3" 30.9°
	V	36.2°	33.6°	23.4°
Operating Temperature	-10°C ~ +50°C			

Distortion	1.1" -0.5%(y=8.8)	1" -0.6%(y=8.0)	2/3" -0.6%(y=5.5)
Back Focal Length	9.4mm		
Flange Back Length	17.526mm		
Mount	C-Mount		
Filter Size	M34.0 P=0.5mm		
Dimensions	φ 39.5mm x 35.2mm		
Weight	91g		

Working Distance (mm)	Optical Magnification	Extension Ring (mm)	Field of View(mm)					
			1.1"		1"		2/3"	
			H	V	H	V	H	V
1000	0.016	-	890.1	651.4	802.4	601.0	550.7	412.4
950	0.017	-	845.4	618.7	762.1	570.9	523.0	391.7
900	0.018	-	800.7	586.0	721.8	540.7	495.4	371.0
850	0.019	-	756.2	553.5	681.7	510.7	467.9	350.5
800	0.020	-	711.5	520.8	641.5	480.5	440.3	329.8
750	0.021	-	666.9	488.1	601.2	450.4	412.7	309.1
700	0.023	-	622.2	455.4	560.9	420.2	385.0	288.4
650	0.025	-	577.4	422.7	520.6	390.0	357.4	267.7
600	0.027	-	532.7	390.0	480.3	359.9	329.7	247.0
550	0.029	-	488.1	357.3	440.0	329.7	302.1	226.3
500	0.032	-	443.4	324.6	399.8	299.6	274.5	205.6
450	0.036	-	398.7	291.9	359.5	269.4	246.9	184.9
400	0.040	-	353.9	259.2	319.2	239.2	219.2	164.2
350	0.046	-	309.3	226.5	278.9	209.1	191.6	143.5
300	0.054	-	264.6	193.8	238.6	178.9	163.9	122.8
250	0.063	1.0	227.8	166.3	205.1	153.3	140.5	105.1
200	0.079	1.0	181.4	132.5	163.4	122.2	111.9	83.8
150	0.106	1.0	135.1	98.8	121.7	91.1	83.5	62.5
100	0.156	2.0	92.1	67.2	82.9	61.9	56.7	42.5

Field of View = CCD Size / Optical Magnification

NEW

V2528-MPY

- 1.1"
- 12MP
- FIX
- MANUAL
- FLOATING

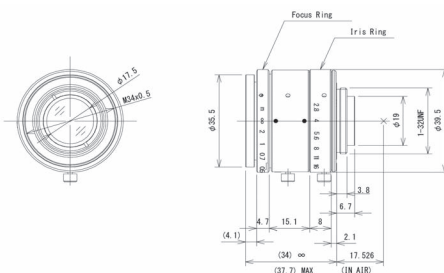

Focal Length	25mm			
Max. Aperture Ratio	1:2.8			
Max. Image Format	14.2mm x 10.4mm (φ 17.6mm)			
Operation Range	Iris F2.8 - F16.0			
	Focus 0.3m - Inf.			
Control	Iris Manual			
	Focus Manual			
Object Dimension at M.O.D.	158.7(H)mm x 116.2(V)mm 1.1"			
Angle of View	D	38.7°	35.4°	24.8°
	H	1.1" 31.7°	1" 28.7°	2/3" 20.0°
	V	23.5°	21.7°	15.0°
Operating Temperature	-10°C ~ +50°C			

Distortion	1.1" 0.3%(y=8.8)	1" 0.2%(y=8.0)	2/3" 0.1%(y=5.5)
Back Focal Length	11.3mm		
Flange Back Length	17.526mm		
Mount	C-Mount		
Filter Size	M34.0 P=0.5mm		
Dimensions	φ 39.5mm x 34mm		
Weight	78g		

Working Distance (mm)	Optical Magnification	Extension Ring (mm)	Field of View(mm)					
			1.1"		1"		2/3"	
			H	V	H	V	H	V
1000	0.026	-	555.5	407.0	500.8	375.7	344.4	258.3
950	0.027	-	527.3	386.3	475.4	356.6	326.9	245.2
900	0.028	-	499.0	365.6	449.9	337.5	309.3	232.0
850	0.030	-	470.7	344.8	424.4	318.3	291.8	218.9
800	0.032	-	442.4	324.1	398.8	299.1	274.2	205.7
750	0.034	-	414.1	303.3	373.3	280.0	256.6	192.5
700	0.037	-	385.7	282.5	347.7	260.8	239.0	179.3
650	0.040	-	357.4	261.7	322.1	241.6	221.5	166.1
600	0.043	-	329.0	240.9	296.6	222.4	203.9	152.9
550	0.047	-	300.7	220.2	271.0	203.2	186.3	139.7
500	0.052	-	272.2	199.3	245.3	184.0	168.6	126.5
450	0.058	-	243.9	178.5	219.8	164.8	151.1	113.3
400	0.066	-	215.5	157.7	194.2	145.6	133.4	100.1
350	0.076	-	187.1	136.9	168.6	126.4	115.8	86.9
300	0.090	-	158.7	116.2	143.0	107.2	98.3	73.7
250	0.108	0.5	131.9	96.5	118.8	89.0	81.6	61.2
200	0.135	1.5	105.6	77.2	95.1	71.3	65.3	48.9
150	0.183	2.5	78.0	57.0	70.3	52.6	48.2	36.1
100	0.281	5.0	50.9	37.2	45.8	34.3	31.4	23.5

Field of View = CCD Size / Optical Magnification

C-MOUNT
1.1" 12MP

1.1" 12 MEGAPIXEL C-MOUNT LENS

MACHINE VISION LENS

- 8, 12, 16, 25, 35, 50mm. 6 Lens Series
- Compatible with 1.1" (φ 17.6mm) Large Format Sensor

- Ultra-High Resolution 12MP
- Compact 1.1" Design (smallest 12MP lens in the industry)

NEW

V3528-MPY

- 1.1"
- 12MP
- FIX
- MANUAL
- FLOATING

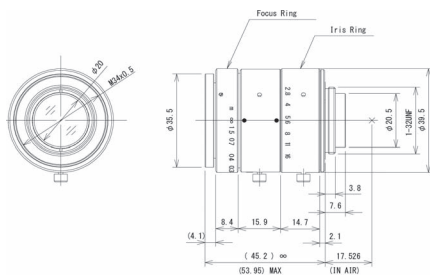

Focal Length	35mm	
Max. Aperture Ratio	1:2.8	
Max. Image Format	14.2mm x 10.4mm (φ 17.6mm)	
Operation Range	Iris	F2.8 - F16.0
	Focus	0.3m - Inf.
Control	Iris	Manual
	Focus	Manual
Object Dimension at M.O.D.	109.3(H)mm x 80.1(V)mm 1.1"	
Angle of View	D	28.2°
	H	22.9°
	V	16.9°
Operating Temperature	1"	25.8°
	2/3"	20.7°
	1.1"	17.9°
Operating Temperature	1"	14.3°
	2/3"	10.8°
	1.1"	10.8°

Distortion	1.1" 0.1%(y=8.8)	1" 0.0%(y=8.0)	2/3" 0.0%(y=5.5)
Back Focal Length	11.7mm		
Flange Back Length	17.526mm		
Mount	C-Mount		
Filter Size	M34.0 P=0.5mm		
Dimensions	φ 39.5mm x 45.2mm		
Weight	103g		

Working Distance (mm)	Optical Magnification	Extension Ring (mm)	Field of View(mm)					
			1.1"		1"		2/3"	
			H	V	H	V	H	V
1000	0.036	-	393.4	288.2	354.6	266.0	243.9	182.9
950	0.038	-	373.0	273.2	336.2	252.2	231.2	173.4
900	0.040	-	352.7	258.4	317.9	238.5	218.6	164.0
850	0.043	-	332.4	243.5	299.6	224.7	206.0	154.5
800	0.046	-	312.1	228.6	281.3	211.0	193.5	145.1
750	0.049	-	291.8	213.8	263.1	197.3	180.9	135.7
700	0.052	-	271.6	198.9	244.8	183.6	168.3	126.3
650	0.057	-	251.3	184.1	226.5	169.9	155.8	116.8
600	0.061	-	231.0	169.2	208.2	156.2	143.2	107.4
550	0.067	-	210.7	154.3	189.9	142.5	130.6	98.0
500	0.075	-	190.4	139.5	171.6	128.8	118.0	88.6
450	0.083	-	170.1	124.6	153.4	115.1	105.5	79.1
400	0.095	-	149.8	109.8	135.1	101.3	92.9	69.7
350	0.110	-	129.5	94.9	116.8	87.6	80.3	60.3
300	0.130	-	109.3	80.1	98.5	73.9	67.8	50.8
250	0.157	1.5	90.4	66.2	81.5	61.1	56.0	42.0
200	0.201	3.0	70.9	51.9	63.9	47.9	43.9	32.9
150	0.277	6.0	51.6	37.7	46.5	34.8	31.9	23.9
100	0.435	15.0	32.9	24.0	29.6	22.2	20.3	15.2

Field of View = CCD Size / Optical Magnification

NEW

V5028-MPY

- 1.1"
- 12MP
- FIX
- MANUAL
- FLOATING

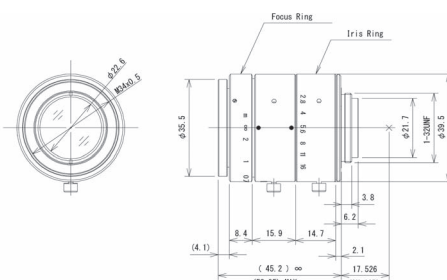

Focal Length	50mm	
Max. Aperture Ratio	1:2.8	
Max. Image Format	14.2mm x 10.4mm (φ 17.6mm)	
Operation Range	Iris	F2.8 - F16.0
	Focus	0.5m - Inf.
Control	Iris	Manual
	Focus	Manual
Object Dimension at M.O.D.	115.9(H)mm x 84.8(V)mm 1.1"	
Angle of View	D	20.0°
	H	16.2°
	V	11.9°
Operating Temperature	1"	18.2°
	2/3"	14.6°
	1.1"	12.6°
Operating Temperature	1"	10.1°
	2/3"	7.6°
	1.1"	7.6°

Distortion	1.1" 0.1%(y=8.8)	1" 0.1%(y=8.0)	2/3" 0.1%(y=5.5)
Back Focal Length	11.9mm		
Flange Back Length	17.526mm		
Mount	C-Mount		
Filter Size	M34.0 P=0.5mm		
Dimensions	φ 39.5mm x 45.1mm		
Weight	107g		

Working Distance (mm)	Optical Magnification	Extension Ring (mm)	Field of View(mm)					
			1.1"		1"		2/3"	
			H	V	H	V	H	V
1000	0.055	-	257.9	188.9	232.5	174.4	159.8	119.9
950	0.058	-	243.7	178.5	219.7	164.7	151.0	113.3
900	0.062	-	229.5	168.1	206.9	155.1	142.2	106.7
850	0.066	-	215.3	157.6	194.0	145.5	133.4	100.0
800	0.071	-	201.1	147.2	181.2	135.9	124.6	93.4
750	0.076	-	186.9	136.8	168.4	126.3	115.8	86.8
700	0.082	-	172.7	126.4	155.6	116.7	107.0	80.2
650	0.090	-	158.5	116.0	142.8	107.1	98.2	73.6
600	0.099	-	144.2	105.6	130.0	97.5	89.4	67.0
550	0.109	-	130.0	95.2	117.2	87.9	80.6	60.4
500	0.123	-	115.9	84.8	104.4	78.3	71.8	53.8
450	0.138	1.0	103.1	75.4	92.9	69.6	63.8	47.9
400	0.158	2.0	89.9	65.8	81.0	60.7	55.7	41.7
350	0.181	5.0	78.5	57.4	70.7	53.0	48.6	36.4
300	0.222	6.0	64.2	47.0	57.8	43.3	39.7	29.8
250	0.276	10.0	51.7	37.8	46.6	34.9	32.0	24.0
200	0.373	15.0	38.2	27.9	34.4	25.8	23.6	17.7
150	0.583	25.0	24.5	17.9	22.1	16.5	15.1	11.3
100	1.255	61.5	11.3	8.3	10.2	7.7	7.0	5.3

Field of View = CCD Size / Optical Magnification

1" 2 MEGA PIXEL LENS

MACHINE VISION LENS

C-MOUNT
1" 2MP

• 8, 12, 16, 25, 50mm. 5 Lens Series • Compatible with 1" (φ 16mm) Large Format Sensor • High Resolution 2 Megapixel

NEW

V0814-MP

1"

2MP

FIX

MANUAL

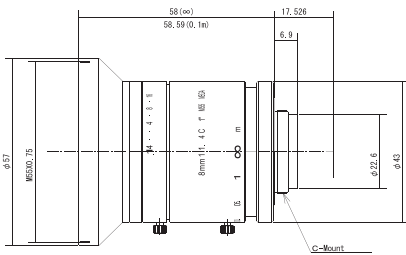

Focal Length	8mm			
Max. Aperture Ratio	1:1.4			
Max. Image Format	12.8mm x 9.6mm (φ 16mm)			
Operation Range	Iris	F1.4 - F16.0		
	Focus	0.1m - Inf.		
Control	Iris	Manual		
	Focus	Manual		
Object Dimension at M.O.D.	19.5cm x 14.2cm 1"			
Angle of View	D	92.4°	82.4°	70.7°
	H	79.7°	1/1.2" 43.9°	2/3" 58.3°
	V	63.0°	47.9°	44.7°
Operating Temperature	-10°C ~ +50°C			

Distortion	1"	-7.07%(y)=8.0)	1/1.2"	-7.30%(y)=6.7)	2/3"	-6.03%(y)=5.5)
Back Focal Length	11.65mm					
Flange Back Length	17.526mm					
Mount	C-Mount					
Filter Size	M55.0 P=0.75mm					
Dimensions	φ 57mm x 58mm					
Weight	250g					

Working Distance (mm)	Optical Magnification	Extension Ring (mm)	Field of View(mm)					
			1"		1/1.2"		2/3"	
			H	V	H	V	H	V
1000	0.007	-	1,947.9	1,423.4	1,712.1	1,075.8	1,333.3	1,000.0
950	0.007	-	1,850.5	1,352.2	1,637.7	1,029.0	1,275.4	956.5
900	0.007	-	1,753.1	1,281.1	1,548.0	972.6	1,205.5	904.1
850	0.008	-	1,655.7	1,209.9	1,467.5	922.1	1,142.9	857.1
800	0.008	-	1,558.3	1,138.7	1,378.1	865.9	1,073.2	804.9
750	0.009	-	1,460.9	1,067.6	1,284.1	806.8	1,000.0	750.0
700	0.009	-	1,363.5	996.4	1,202.1	755.3	936.2	702.1
650	0.010	-	1,266.1	925.2	1,118.8	703.0	871.3	653.5
600	0.011	-	1,168.7	854.0	1,027.3	645.5	800.0	600.0
550	0.012	-	1,071.4	782.9	949.6	596.6	739.5	554.6
500	0.013	-	974.0	711.7	862.6	542.0	671.8	503.8
450	0.015	-	876.6	640.5	774.0	486.3	602.7	452.1
400	0.016	-	779.2	569.4	689.0	432.9	536.6	402.4
350	0.019	-	681.8	498.2	601.1	377.7	468.1	351.1
300	0.022	-	584.4	427.0	516.0	324.2	401.8	301.4
250	0.026	-	487.0	355.9	429.7	270.0	334.6	251.0
200	0.033	-	389.6	284.7	343.5	215.8	267.5	200.6
150	0.044	-	292.2	213.5	258.0	162.1	200.9	150.7
100	0.066	-	194.8	142.3	170.0	103.0	129.6	95.4

Field of View = CCD Size / Optical Magnification

NEW

V1214-MP

1"

2MP

FIX

MANUAL

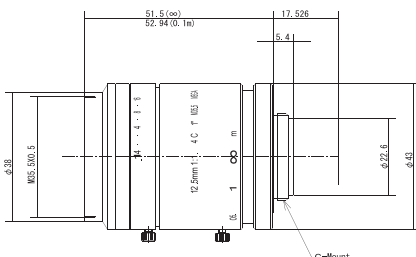

Focal Length	12.5mm			
Max. Aperture Ratio	1:1.4			
Max. Image Format	12.8mm x 9.6mm (φ 16mm)			
Operation Range	Iris	F1.4 - F16.0		
	Focus	0.1m - Inf.		
Control	Iris	Manual		
	Focus	Manual		
Object Dimension at M.O.D.	11.9cm x 8.8cm 1"			
Angle of View	D	67.6°	58.0°	48.4°
	H	56.5°	1/1.2" 49.6°	2/3" 39.1°
	V	42.5°	31.7°	29.5°
Operating Temperature	-10°C ~ +50°C			

Distortion	1"	-5.93%(y)=8.0)	1/1.2"	-4.9%(y)=6.7)	2/3"	-3.63%(y)=5.5)
Back Focal Length	12.55mm					
Flange Back Length	17.526mm					
Mount	C-Mount					
Filter Size	M35.5 P=0.5mm					
Dimensions	φ 38mm x 51.5mm					
Weight	175g					

Working Distance (mm)	Optical Magnification	Extension Ring (mm)	Field of View(mm)					
			1"		1/1.2"		2/3"	
			H	V	H	V	H	V
1000	0.011	-	1,192.7	877.6	1,056.1	663.6	822.4	616.8
950	0.011	-	1,133.1	833.7	1,000.0	628.3	778.8	584.1
900	0.012	-	1,073.4	789.8	949.6	596.6	739.5	554.6
850	0.013	-	1,013.8	746.0	896.8	563.5	698.4	523.8
800	0.013	-	954.2	702.1	843.3	529.9	656.7	492.5
750	0.014	-	894.5	658.2	790.2	496.5	615.4	461.5
700	0.015	-	834.9	614.3	738.6	464.1	575.2	431.4
650	0.017	-	775.3	570.4	684.9	430.3	533.3	400.0
600	0.018	-	715.6	526.6	631.3	396.7	491.6	368.7
550	0.020	-	656.0	482.7	579.5	364.1	451.3	338.5
500	0.022	-	596.4	438.8	525.6	330.2	409.3	307.0
450	0.024	-	536.7	394.9	474.8	298.3	369.8	277.3
400	0.027	-	477.1	351.0	421.6	264.9	328.4	246.3
350	0.031	-	417.5	307.2	368.1	231.3	286.6	215.0
300	0.036	-	357.0	262.7	314.8	197.8	245.1	183.8
250	0.043	-	298.2	219.4	263.4	165.5	205.1	153.9
200	0.054	-	238.5	175.5	210.4	132.2	163.9	122.9
150	0.072	-	178.9	131.6	158.0	99.3	123.1	92.3
100	0.107	-	119.3	87.8	104.3	64.1	80.1	59.5

Field of View = CCD Size / Optical Magnification



1" 2 MEGAPIXEL LENS

MACHINE VISION LENS

- 8, 12, 16, 25, 50mm. 5 Lens Series
- Compatible with 1" (φ 16mm) Large Format Sensor
- High Resolution 2 Megapixel

NEW

V1614-MP

- 1"
- 2MP
- FIX
- MANUAL

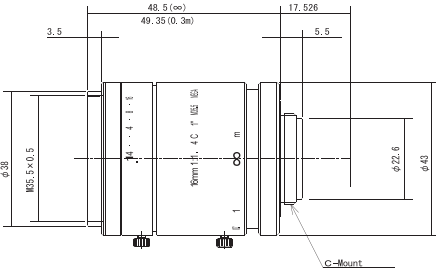

Focal Length	16mm			
Max. Aperture Ratio	1:1.4			
Max. Image Format	12.8mm x 9.6mm (φ 16mm)			
Operation Range	Iris	F1.4 - F16.0		
	Focus	0.3m - Inf.		
Control	Iris	Manual		
	Focus	Manual		
Object Dimension at M.O.D.	25.2cm x 18.7cm 1"			
Angle of View	D	54.4°	46.2°	38.3°
	H	1" 44.3°	1/1.2" 39.3°	2/3" 30.3°
	V	33.6°	24.9°	23.2°
Operating Temperature	-10°C ~ +50°C			

Distortion	1"	3.84%(y=-8.0)	1/1.2"	-3.0%(y=-6.7)	2/3"	-2.24%(y=-5.5)
Back Focal Length	12.14mm					
Flange Back Length	17.526mm					
Mount	C-Mount					
Filter Size	M 35.5 P=0.5mm					
Dimensions	φ 38mm x 48.5mm					
Weight	170g					

Working Distance (mm)	Optical Magnification	Extension Ring (mm)	Field of View(mm)					
			1"		1/1.2"		2/3"	
			H	V	H	V	H	V
1000	0.015	-	840.4	622.5	743.4	467.1	579.0	434.2
950	0.016	-	798.4	591.3	706.3	443.8	550.0	412.5
900	0.017	-	756.4	560.2	668.6	420.1	520.7	390.5
850	0.018	-	714.3	529.1	631.3	396.7	491.6	368.7
800	0.019	-	672.3	498.0	594.7	373.7	463.2	347.4
750	0.020	-	630.3	466.9	556.7	349.8	433.5	325.1
700	0.022	-	588.3	435.7	518.4	325.7	403.7	302.8
650	0.023	-	546.3	404.6	482.9	303.4	376.1	282.1
600	0.025	-	504.2	373.5	444.9	279.5	346.5	259.8
550	0.028	-	462.2	342.4	407.9	256.3	317.7	238.3
500	0.031	-	420.2	311.2	370.5	232.8	288.5	216.4
450	0.034	-	378.2	280.1	334.3	210.1	260.4	195.3
400	0.038	-	336.2	249.3	296.6	186.4	231.0	173.2
350	0.044	-	294.1	217.9	259.8	163.2	202.3	151.7
300	0.051	-	252.1	186.7	221.2	137.0	170.7	127.2
250	0.070	1.0	182.4	136.8	161.0	101.1	125.4	94.0
200	0.090	1.5	142.9	107.3	126.3	79.3	98.3	73.7
150	0.124	2.0	103.4	77.6	91.4	57.4	71.1	53.4
100	0.200	3.0	63.9	48.0	56.4	35.5	44.0	33.0

Field of View = CCD Size / Optical Magnification

NEW

V2514-MP

- 1"
- 2MP
- FIX
- MANUAL

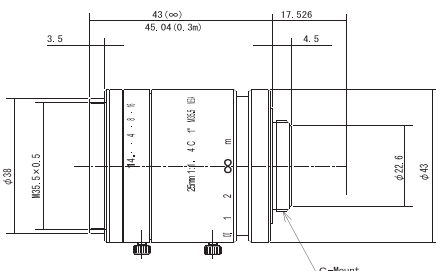

Focal Length	25mm			
Max. Aperture Ratio	1:1.4			
Max. Image Format	12.8mm x 9.6mm (φ 16mm)			
Operation Range	Iris	F1.4 - F16.0		
	Focus	0.3m - Inf.		
Control	Iris	Manual		
	Focus	Manual		
Object Dimension at M.O.D.	16.1cm x 11.9cm 1"			
Angle of View	D	36.6°	30.7°	25.2°
	H	1" 29.3°	1/1.2" 25.9°	2/3" 20.2°
	V	22.0°	16.3°	15.1°
Operating Temperature	-10°C ~ +50°C			

Distortion	1"	-3.14%(y=-8.0)	1/1.2"	-2.2%(y=-6.7)	2/3"	-1.48%(y=-5.5)
Back Focal Length	15.71mm					
Flange Back Length	17.526mm					
Mount	C-Mount					
Filter Size	M35.5 P=0.5mm					
Dimensions	φ 38mm x 43mm					
Weight	150g					

Working Distance (mm)	Optical Magnification	Extension Ring (mm)	Field of View(mm)					
			1"		1/1.2"		2/3"	
			H	V	H	V	H	V
1000	0.024	-	536.3	401.7	472.8	297.1	368.2	276.2
950	0.025	-	509.5	382.5	450.2	282.9	350.6	263.0
900	0.027	-	482.6	362.3	426.4	267.9	332.1	249.1
850	0.028	-	455.8	341.6	402.1	252.7	313.2	234.9
800	0.030	-	429.0	322.2	379.2	238.3	295.3	221.5
750	0.032	-	402.2	301.9	355.4	223.3	276.7	207.6
700	0.034	-	375.4	281.5	331.4	208.2	258.1	193.6
650	0.037	-	348.6	261.6	307.9	193.5	239.8	179.8
600	0.040	-	321.8	241.2	283.9	178.4	221.1	165.8
550	0.043	-	295.0	221.2	260.4	163.6	202.8	152.1
500	0.048	-	268.1	201.3	236.9	148.9	184.5	138.4
450	0.053	-	241.3	181.1	213.2	134.0	166.0	124.5
400	0.060	-	214.5	160.8	189.3	118.9	147.4	110.6
350	0.068	-	187.7	140.8	165.7	104.1	129.0	96.8
300	0.080	-	160.9	119.2	141.2	87.6	109.1	81.3
250	0.106	2.5	120.7	90.6	106.6	67.0	83.0	62.3
200	0.135	3.5	95.1	71.3	84.0	52.8	65.4	49.0
150	0.184	4.5	69.5	52.2	61.4	38.6	47.8	35.9
100	0.291	7.5	43.9	32.9	38.8	24.4	30.2	22.7

Field of View = CCD Size / Optical Magnification

MACRO
ZOOM

MACRO ZOOM LENS

MACHINE VISION LENS

- Wide zoom range for general inspection, documentation, and visual aid applications

MLH-10X

- 1/2"
- MACRO
- ZOOM
- MANUAL



Optical Magnification	0.084X - 0.84X			
Max. Magnification	0.084mm - 0.84mm			
Max. Aperture Ratio	1:5.6			
Max. Image Format	6.4mm x 4.8mm (φ 8mm)			
Operation Range	Iris	F5.6 - F32C		
	Focus	0.15m - 0.45m		
Control	Iris	Manual		
	Focus	Manual		
	Zoom	Manual		
Angle of View	D	21.6° - 4.5°	17.0° - 3.3°	13.0° - 2.5°
	H	1/2" 18.0° - 3.6°	1/3" 13.8° - 2.7°	1/4" 10.6° - 2.0°
	V	13.8° - 2.7°	10.6° - 2.0°	8.0° - 1.5°
Operating Temperature	-10° C ~ +50° C			

Distortion	1/2"	+0.9% at 0.084X (y=4.0)
		+1.6% at 0.84X (y=4.0)
Back Focal Length	23.29mm	
Flange Back Length	17.526mm	
Mount	C-Mount	
Filter Size	M46 P=0.75mm	
Dimensions	φ 48mm x 98.5mm	
Weight	260g	

Working Distance (mm)	Optical Magnification	Field of View(mm)												
		1/2"			Magnification on Monitor	1/3"			Magnification on Monitor	1/4"			Magnification on Monitor	
		H	V	D		H	V	D		H	V	D		
150	Wide	0.084X	76.2	57.1	95.2	3.73X	57.1	42.9	71.4	4.98X	42.9	32.1	53.6	6.64X
	Middle	0.19X	33.5	25.2	42.3	8.47X	25.2	18.9	31.4	11.29X	18.9	14.2	23.6	15.06X
	Tele	0.84X	7.6	5.7	9.5	37.34X	5.7	4.3	7.1	49.78X	4.3	3.2	5.4	66.38X
200	Wide	0.06X	106.7	80.0	133.3	2.67X	80.0	60.0	100.0	3.56X	60.0	45.0	75.0	4.74X
	Middle	0.13X	47.8	36.1	59.4	5.87X	36.1	27.2	44.9	7.83X	27.2	20.4	33.9	10.44X
	Tele	0.60X	10.7	8.0	13.3	26.67X	8.0	6.0	10.0	35.56X	6.0	4.5	7.5	47.41X
250	Wide	0.045X	142.2	106.7	177.8	2.00X	106.7	80.0	133.3	2.67X	80.0	60.0	100.0	3.56X
	Middle	0.101X	62.3	47.1	77.0	4.49X	47.1	35.5	58.5	5.99X	35.5	26.7	44.2	7.98X
	Tele	0.45X	14.2	10.7	17.8	20.00X	10.7	8.0	13.3	26.67X	8.0	6.0	10.0	35.56X
300	Wide	0.036X	177.8	133.3	222.2	1.60X	133.3	100.0	166.7	2.13X	100.0	75.0	125.0	2.84X
	Middle	0.082X	76.8	58.2	94.8	3.63X	58.2	43.8	72.2	4.84X	43.8	33.0	54.6	6.46X
	Tele	0.36X	17.8	13.3	22.2	16.00X	13.3	10.0	16.7	21.34X	10.0	7.5	12.5	28.45X
350	Wide	0.03X	213.3	160.0	266.7	1.33X	160.0	120.0	200.0	1.78X	120.0	90.0	150.0	2.37X
	Middle	0.069X	91.4	69.3	112.7	3.05X	69.3	52.2	85.9	4.07X	52.2	39.3	65.0	5.42X
	Tele	0.30X	21.3	16.0	26.7	13.34X	16.0	12.0	20.0	17.78X	12.0	9.0	15.0	23.71X
400	Wide	0.025X	256.0	192.0	320.0	1.11X	192.0	144.0	240.0	1.48X	144.0	108.0	180.0	1.98X
	Middle	0.06X	106.0	80.3	130.7	2.63X	80.3	60.6	99.7	3.5X	60.6	45.6	75.4	4.67X
	Tele	0.25X	25.6	19.2	32.0	11.11X	19.2	14.4	24.0	14.82X	14.4	10.8	18.0	19.76X
450	Wide	0.022X	290.9	218.2	363.6	0.98X	218.2	163.6	272.7	1.30X	163.6	122.7	204.5	1.74X
	Middle	0.05X	120.7	91.5	148.7	2.31X	91.5	69.0	113.5	3.08X	69.0	51.9	85.9	4.1X
	Tele	0.22X	29.1	21.8	36.4	9.78X	21.8	16.4	27.3	13.04X	16.4	12.3	20.5	17.38X

Field of View : Horizontal (mm) x Vertical (mm) x Diagonal (mm)
 Monitor Magnification on 14inch Monitor
 Magnification on Monitor = Optical Magnification x Monitor Size / CCD Size

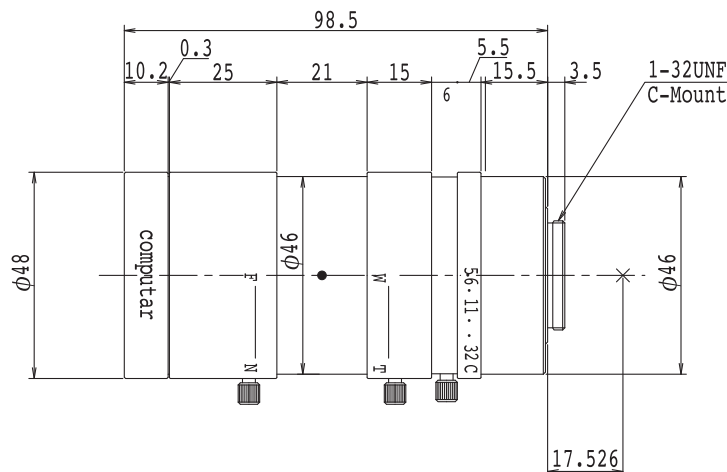

MEGAPIXEL MACRO ZOOM LENS

MACHINE VISION LENS

MACRO
ZOOM

- Captures full resolution of megapixel cameras
- High contrast & sharp picture in all areas of the screen
- Compact design-Diameter 36.5mm
- Locking set screws for zoom, focus, and iris
- Low distortion
- High resolution macro zoom lens
- 3.3X magnification
- Attachment of fiber ring light can be installed (Ring Guide: M34 P=0.5)

2/3"

1MP

MACRO

ZOOM

MANUAL

MLM-3XMP



Max. Magnification	0.3X - 1.0X			Distortion	2/3"	+0.12% at 0.3X (y=5.5)	-0.12% at 0.3X (y=4.0)	
Max. Aperture Ratio	1:4.5					+1.78% at 1.0X (y=5.5)	+0.77% at 1.0X (y=4.0)	
Max. Image Format	8.8mm x 6.6mm (φ 11mm)			Back Focal Length	20.4mm			
Operation Range	Iris	F4.5 - F22C			Flange Back Length	17.526mm		
	Focus	90mm			Mount	C-Mount		
Control	Iris	Manual			Filter Size	M34 P=0.5mm		
	Focus	Manual			Dimensions	φ 36.5mm x 79.5mm		
	Zoom	Manual			Weight	150g		
Angle of View	D	14.88° - 2.84°		1/2"	10.70° - 2.72°			
	H	11.80° - 2.78°			8.48° - 2.18°			
	V	8.74° - 2.24°			6.38° - 1.64°			
Operating Temperature	-10° C ~ +50° C							

Monitor Magnification on 14inch Monitor

Working Distance: 90mm

Magnification on Monitor = Optical Magnification x Monitor Size / CCD Size

Optical Magnification	Field of View(mm)											
	2/3"			Magnification on Monitor	1/2"			Magnification on Monitor	1/3"			Magnification on Monitor
	H	V	D		H	V	D		H	V	D	
0.3X	29.3	22.0	36.7	9.7X	21.3	16.0	26.7	13.3X	16.0	12.0	20.0	17.8X
0.4X	22.0	16.5	27.5	12.9X	16.0	12.0	20.0	17.8X	12.0	9.0	15.0	23.7X
0.5X	17.6	13.2	22.0	16.2X	12.8	9.6	16.0	22.2X	9.6	7.2	12.0	29.6X
0.6X	14.7	11.0	18.3	19.4X	10.7	8.0	13.3	26.7X	8.0	6.0	10.0	35.6X
0.7X	12.6	9.4	15.7	22.6X	9.1	6.9	11.4	31.1X	6.9	5.1	8.6	41.5X
0.8X	11.0	8.3	13.8	25.9X	8.0	6.0	10.0	35.6X	6.0	4.5	7.5	47.4X
0.9X	9.8	7.3	12.2	29.1X	7.1	5.3	8.9	40.0X	5.3	4.0	6.7	53.3X
1.0X	8.8	6.6	11.0	32.3X	6.4	4.8	8.0	44.5X	4.8	3.6	6.0	59.3X

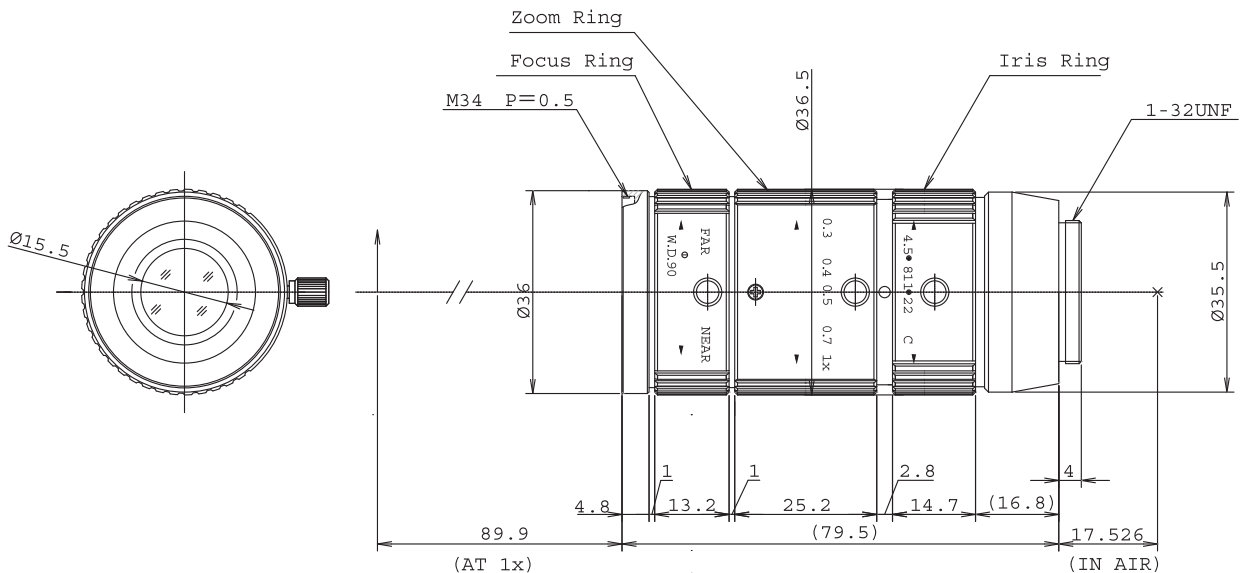

5 MEGAPIXEL TELECENTRIC MACRO ZOOM LENS

MACHINE VISION LENS

- 5 megapixel resolution for a 1.1-inch sensor
- 7.1X magnification (0.5X - 0.07X)
- Relative Illumination rate is more than 70%

- Adjustable W.D. (182mm - 577.2mm)
- Telecentric design at 0.25X - 0.5X

TEC-V7X

- 1.1"
- 5MP
- TELECEN
- MACRO
- ZOOM
- MANUAL



Optical Magnification	0.07X - 0.5X
Max. Aperture Ratio	1 : 4.3
Max. Image Format	12.3mm x 12.3mm (φ 17.4mm)
Operation Range	Iris F4.3 - F32
	Focus 182mm - 577.2mm
Control	Iris Manual operation
	Focus Manual operation
	Zoom Manual operation
Operating Temperature	-10° C ~ 50° C

Optical distortion	tele	1.0%	1"	0.84%	2/3"	0.39%
	wide	-1.7%		-1.45%		-0.7%
BackFocal Length	tele	39.53mm				
	wide	49.78mm				
Flange Back Length	17.526mm					
Mount	C Mount					
Filter Size	M62 P=0.75mm					
Dimensions	φ 61 x 152.86mm					
Weight	1.4kg					

Working Distance(mm)	Optical Magnification	Field of View(mm)									
		1.1"			1"			2/3"			
(mm)		H	V	D	H	V	D	H	V	D	
182	Wide	0.2525	48.74	48.74	69.12	50.32	38.06	63.28	34.88	26.16	43.6
	Middle	0.3643	33.64	33.64	47.33	34.72	26.3	43.6	24.12	18.1	30.11
	Tele	0.5	24.6	24.6	34.75	25.4	19.246	31.88	17.65	13.26	22
200	Wide	0.2258	54.52	54.62	76.94	56.3	42.56	70.84	39	29.24	48.76
	Middle	0.3258	37.62	37.62	52.95	38.83	29.4	48.78	26.96	20.24	33.67
	Tele	0.4451	27.5	27.5	38.68	28.38	21.51	35.64	19.72	14.81	24.62
300	Wide	0.1413	87.48	87.48	124.06	90.34	68.18	114.1	62.46	46.8	78.178
	Middle	0.2037	60.24	60.24	85.34	62.18	47.06	78.18	42.15	32.38	53.898
	Tele	0.2784	44	44	61.94	45.42	34.3	57.46	31.55	23.69	39.38
400	Wide	0.1037	119.47	119.47	169.98	123.4	93.02	156.05	85.2	63.82	106.71
	Middle	0.1495	82.15	82.15	115.97	84.8	64.16	106.72	58.82	44.12	73.48
	Tele	0.2042	59.99	59.99	84.52	61.92	46.89	77.82	43	32.28	53.7
500	Wide	0.082	151.25	151.25	215.44	156.25	117.67	197.8	107.78	80.68	135.04
	Middle	0.1183	103.92	103.92	146.82	107.28	81.12	135	74.37	55.78	92.94
	Tele	0.1617	75.84	75.84	106.89	78.29	59.28	98.4	54.36	40.8	67.88
577.5	Wide	0.0708	175.21	175.21	250.66	181.4	136.35	229.82	125.08	93.62	156.76
	Middle	0.102	120.57	120.57	170.44	124.47	94.1	156.74	86.28	64.72	107.84
	Tele	0.1398	87.99	87.99	124.04	90.8	68.75	114.16	63.06	47.32	78.74

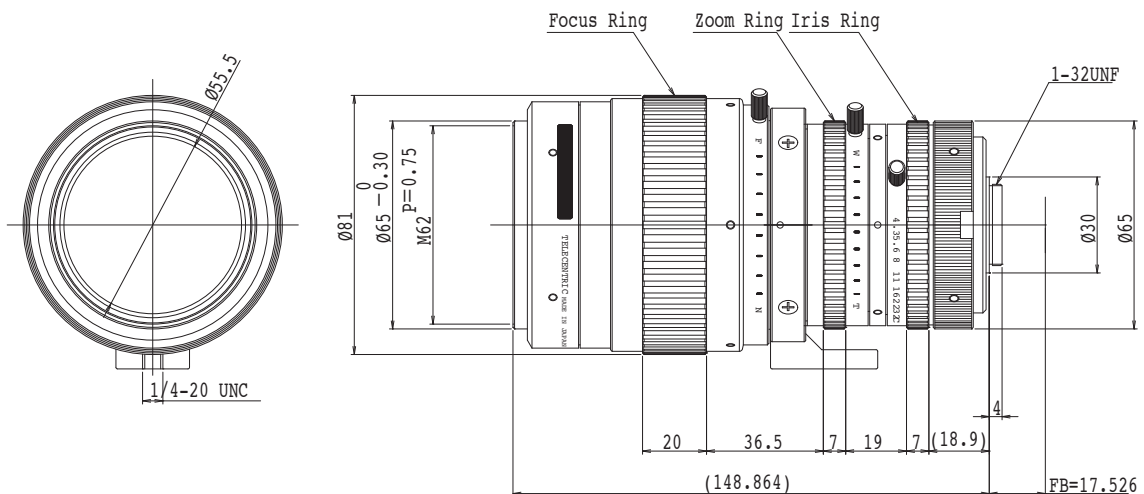

5 MEGAPIXEL TELECENTRIC LENS

MACHINE VISION LENS

TELECEM
MACRO
ZOOM

- Compact body design, compatible with 5MP sensors
- Optical magnification 0.057x - 0.5x

- Relative Illuminance more than 80%
- Low distortion, less than 1%

TEC-M55MPW

- 2/3"
- 5MP
- TELECEM
- MACRO
- ZOOM
- MANUAL



Focal length	55mm (at 0.057X) 51mm (at 0.5X)	Distortion	2/3"	+0.52% at 0.057x (y=5.5) +0.6% at 0.5x (y=5.5)
Max Aperture Ratio	1:3.0	Back focal length	17.0mm	
Max. Image Format	8.8mm x 6.6mm (φ11mm)	Flange Back Length	17.526mm	
Operation Iris Range	F3.0-F22C	Mount	C-Mount	
Focus	139mm - 1000mm	Filter Size	M46.0 P=0.75mm	
Magnification	0.057x - 0.5x	Dimensions	φ59.0mm x 93.1mm	
Relative Illumination	94% (at 0.057x) 81% (at 0.5x)	Weight	470g	
Control Iris	Manual			
Control Focus	Manual			
Object Dimension at M.O.D	1.7(H)cm x 1.3(V)cm 2/3"			
Operation Temperature	-10° C ~ 50° C			

Working Distance(mm)	Optical Magnification (X)	Field of View(mm)					
		2/3"		1/2"		1/3"	
(mm)	(X)	H	V	H	V	H	V
1000	0.057	154.4	115.8	112.3	84.2	84.2	63.2
950	0.060	146.7	110.0	106.7	80.0	80.0	60.0
900	0.064	137.5	103.1	100.0	75.0	75.0	56.3
850	0.067	131.3	98.5	95.5	71.6	71.6	53.7
800	0.072	122.2	91.7	88.9	66.7	66.7	50.0
750	0.077	114.3	85.7	83.1	62.3	62.3	46.8
700	0.083	106.0	79.5	77.1	57.8	57.8	43.4
650	0.089	98.9	74.2	71.9	53.9	53.9	40.4
600	0.097	90.7	68.0	66.0	49.5	49.5	37.1
550	0.106	83.0	62.3	60.4	45.3	45.3	34.0
500	0.118	74.6	55.9	54.2	40.7	40.7	30.5
450	0.132	66.7	50.0	48.5	36.4	36.4	27.3
400	0.150	58.7	44.0	42.7	32.0	32.0	24.0
350	0.173	50.9	38.2	37.0	27.7	27.7	20.8
300	0.204	43.1	32.4	31.4	23.5	23.5	17.6
250	0.251	35.1	26.3	25.5	19.1	19.1	14.3
200	0.323	27.2	20.4	19.8	14.9	14.9	11.1
150	0.456	19.3	14.5	14.0	10.5	10.5	7.9
140	0.504	17.5	13.1	12.7	9.5	9.5	7.1

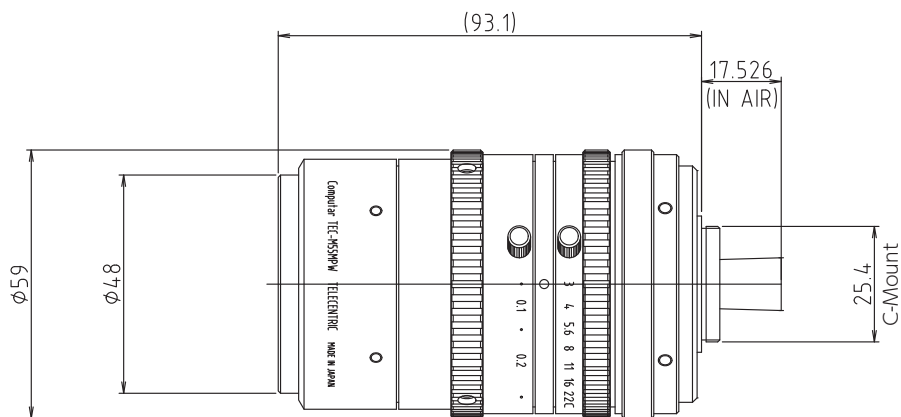

TELECENTRIC LENS

MACHINE VISION LENS

- Very low distortion compared to standard macro lens
- Wide depth of field
- Working distance: 140mm - Infinity

- Suitable for use as a telephoto lens and macro lens
- Fast F2.8 F-stop at Infinity

TEC-M55

- 2/3"
- TELECEM
- MACRO
- ZOOM
- MANUAL



Focal Length	55mm
Max. Aperture Ratio	1:2.8
Max. Image Format	8.8mm x 6.6mm (φ 11mm)
Operation Range	Iris F2.8 - F32C
	Focus 0.14m - Inf.
Magnification	Inf. - 0.5X (Max 1.0X at 140mm with 2X Converter)
Relative Illumination	78.5% (at 0.5X)
Depth of Field 1/2"	3.5mm(at 0.5X F2.8), 6.0mm(at 0.5X F5.6)
Control	Iris Manual
	Focus Manual
Object Dimension at M.O.D	1.7(H)cm x 1.3(V)cm 2/3"
Operating Temperature	-10° C ~ +50° C

Distortion	2/3"	+0.2% at 0.2X (y=5.5)	1/2"	+0.1% at 0.2X (y=4.0)
		+0.6% at 0.5X (y=5.5)		
Back Focal Length	29.8mm			
Flange Back Length	17.526mm			
Mount	C-Mount			
Filter Size	M43 P=0.75mm			
Dimensions	φ 53.0mm x 92.9mm (Max. at 0.5X)			
Weight	320g			

TEC-M55

Working Distance (mm)	Optical Magnification	Field of View(mm)					
		2/3"		1/2"		1/3"	
		H	V	H	V	H	V
5000	0.011X	796.2	597.8	579.7	435.0	435.0	326.3
4000	0.014X	636.1	477.6	463.1	347.5	347.5	260.7
3000	0.018X	476.0	357.4	346.6	260.1	260.1	195.1
2000	0.028X	315.9	237.2	230.0	172.6	172.6	129.5
1500	0.037X	235.9	177.1	177.1	128.9	128.9	96.7
1000	0.056X	155.8	117.0	113.4	85.1	85.1	63.9
950	0.059X	147.8	111.0	107.6	80.7	80.7	60.6
900	0.063X	139.8	105.0	101.8	76.4	76.4	57.3
850	0.067X	131.8	99.0	96.0	72.0	72.0	54.0
800	0.071X	123.8	92.9	90.1	67.6	67.6	50.7
750	0.076X	115.8	86.9	84.3	63.2	63.2	47.4
700	0.081X	107.8	80.9	78.5	58.9	58.9	44.2
650	0.088X	99.8	74.9	72.6	55.5	55.5	40.9
600	0.096X	91.8	68.9	66.8	50.1	50.1	37.6
550	0.105X	83.8	62.9	61.0	45.8	45.8	34.3
500	0.116X	75.8	56.9	55.2	41.4	41.4	31.0
450	0.130X	67.8	50.9	49.3	37.0	37.0	27.8
400	0.147X	59.8	44.9	43.5	32.6	32.6	24.5
350	0.170X	51.8	38.8	37.7	28.3	28.3	21.2
300	0.201X	43.8	32.8	31.8	23.9	23.9	17.9
250	0.246X	35.7	26.8	26.0	19.5	19.5	14.6
200	0.317X	27.7	20.8	20.2	15.1	15.1	11.4
150	0.446X	19.7	14.8	14.3	10.8	10.8	8.1
140	0.486X	18.1	13.6	13.2	9.9	9.9	7.4

TEC-M55 with 0.75X Converter

Working Distance (mm)	Optical Magnification	Field of View(mm)					
		2/3"		1/2"		1/3"	
		H	V	H	V	H	V
5000	0.008X	1066.2	797.6	773.3	579.2	579.2	434.0
4000	0.010X	851.9	637.3	617.8	462.7	462.7	346.8
3000	0.014X	637.6	476.9	462.4	346.3	346.3	259.5
2000	0.021X	423.2	316.6	306.9	229.9	229.9	172.3
1500	0.028X	316.1	236.4	229.2	171.7	171.7	128.6
1000	0.423X	208.9	156.2	151.5	113.4	113.4	85.0
950	0.045X	198.2	148.2	143.7	107.6	107.6	80.6
900	0.047X	187.4	140.2	135.9	101.8	101.8	76.3
850	0.050X	176.7	132.2	128.1	96.0	96.0	71.9
800	0.053X	166.0	124.2	120.4	90.1	90.1	67.5
750	0.057X	155.3	116.1	112.6	84.3	84.3	63.2
700	0.061X	144.6	108.1	104.8	78.5	78.5	58.8
650	0.066X	133.8	100.1	97.0	72.7	72.7	54.5
600	0.072X	123.1	92.1	89.3	66.8	66.8	50.1
550	0.079X	112.4	84.1	81.5	61.0	61.0	45.7
500	0.087X	101.7	76.0	73.7	55.2	55.2	41.4
450	0.097X	90.9	68.0	65.9	49.4	49.4	37.0
400	0.110X	80.2	60.0	58.2	43.6	43.6	32.6
350	0.127X	69.5	52.0	50.4	37.7	37.7	28.3
300	0.151X	58.7	43.9	42.6	31.9	31.9	23.9
250	0.184X	48.0	35.9	34.8	26.1	26.1	19.5
200	0.238X	37.3	27.9	27.0	20.2	20.2	15.2
150	0.334X	26.5	19.8	19.2	14.4	14.4	10.8
140	0.363X	24.4	18.2	17.7	13.2	13.2	9.9

TEC-M55 with 2X Converter

Working Distance (mm)	Optical Magnification	Field of View(mm)					
		2/3"		1/2"		1/3"	
		H	V	H	V	H	V
5000	0.019X	453.1	340.3	330.0	247.7	247.7	185.8
4000	0.024X	362.0	271.9	263.6	197.9	197.9	148.5
3000	0.032X	270.9	203.4	197.3	148.1	148.1	111.1
2000	0.049X	179.8	135.0	130.9	98.3	98.3	73.7
1500	0.065X	134.3	100.8	97.8	73.4	73.4	55.0
1000	0.098X	88.7	66.6	64.6	48.5	48.5	36.4
950	0.104X	84.1	63.2	61.3	46.0	46.0	34.5
900	0.110X	79.6	59.8	58.0	43.5	43.5	32.6
850	0.116X	75.0	56.3	54.6	41.0	41.0	30.8
800	0.124X	70.5	52.9	51.3	38.5	38.5	28.9
750	0.133X	65.9	49.5	48.0	36.0	36.0	27.0
700	0.142X	61.4	46.1	44.7	33.5	33.5	25.2
650	0.154X	56.8	42.7	41.4	31.0	31.0	23.3
600	0.167X	52.3	39.2	38.1	28.6	28.6	21.4
550	0.183X	47.7	35.8	34.7	26.1	26.1	19.6
500	0.203X	43.2	32.4	31.4	23.6	23.6	17.7
450	0.227X	38.6	29.0	28.1	21.1	21.1	15.8
400	0.257X	34.0	25.6	24.8	18.6	18.6	14.0
350	0.297X	29.5	22.1	21.5	16.1	16.1	12.1
300	0.352X	24.9	18.7	18.2	13.6	13.6	10.2
250	0.431X	20.4	15.3	14.8	11.1	11.1	8.4
200	0.558X	15.8	11.9	11.5	8.7	8.7	6.5
150	0.789X	11.3	8.5	8.2	6.2	6.2	4.6
140	0.861X	10.4	7.8	7.6	5.7	5.7	4.3

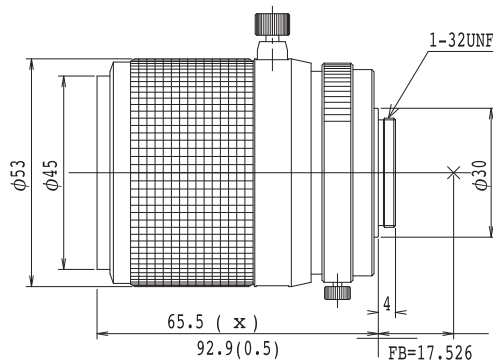

2X Converter

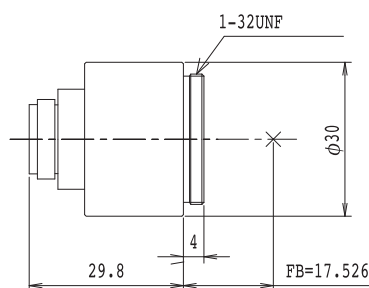

0.75X Converter

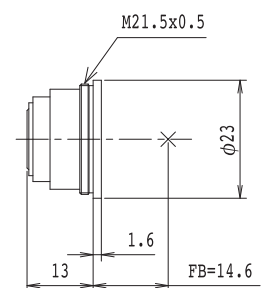

ACCESSORIES



MODEL NO.	EX1.5CS
Description	1.5X Extender for CS-mount
Application	Attached between lens and camera - Makes focal length 1.5X



MODEL NO.	EX1.5C
Description	1.5X Extender for C-mount
Application	Attached between lens and camera - Makes focal length 1.5X



MODEL NO.	EX2CS
Description	2X Extender for CS-mount
Application	Attached between lens and camera - Makes focal length 2X



MODEL NO.	EX2C
Description	2X Extender for C-mount
Application	Attached between lens and camera - Makes focal length 2X



MODEL NO.	VM100
Description	Extension Tube Kit 40, 20, 10, 5, 1, 0.5mm
Application	Attached between lens and camera - Reduces minimum focusing distance



MODEL NO.	VM400
Description	5mm Adapter Ring
Application	Attached between lens and camera - Adapts C-mount lens to CS-mount camera



MODEL NO.	M55-0.75X
Description	Rear converter 0.75X (Designed for TEC-M55)
Application	Makes focal length 0.75X



MODEL NO.	M55-2.0X
Description	Rear converter 2.0X (Designed for TEC-M55)
Application	Makes focal length 2.0X



MODEL NO.	VM0811
Description	Filter holder for V0828-MPY (M72 P=0.75)
Application	Attached between filter and lens for 1.1" sensor camera



MODEL NO.	VM0810
Description	Filter holder for V0828-MPY (M67 P=0.75)
Application	Attached between filter and lens for 1" sensor camera



SWIR LENS

MACHINE VISION / SECURITY LENS

- Designed for SWIR (800-1700nm) range
- Compact & Light weight

- Low F-stop
- Covers 640 x 512, 15µm Sensor

M1614-SW

- 2/3"
- SWIR
- FIX
- MANUAL

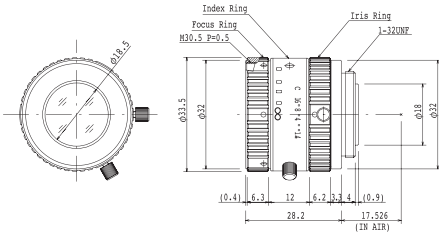

Focal Length	16mm		
Max. Aperture Ratio	1:1.4		
Max. Image Circle	φ 12.3mm		
Operation Range	Iris	F1.4 - F16C	
	Focus	0.3m - Inf.	
Control	Iris	Manual	
	Focus	Manual	
Object Dimension at M.O.D.	17.0(H)cm x 12.7(V)cm 2/3"		
Angle of View	D	37.7°	27.9°
	H	2/3" 30.6°	1/2" 22.5°
	V	23.2°	16.9°
Operating Temperature	-10° C ~ +50° C		

Distortion	2/3"	-0.5% (y=5.5)	1/2"	-0.5% (y=4.0)
Back Focal Length	13.3mm (Inf)			
Flange Back Length	17.526mm			
Mount	C-Mount			
Filter Size	M30.5 P=0.5mm			
Dimensions	φ 33.5mm x 28.2mm			
Weight	60g			

Angle of View (InGaAs Detector)	D	640 x 512 (Pixel Pitch : 15µm)	41.7°	320 x 256 (Pixel Pitch : 25µm)	35.3°	320 x 256 (Pixel Pitch : 20µm)	28.6°
	H	H9.60mm x V7.68mm	33.2°	H8.00mm x V6.40mm	27.9°	H6.40mm x V5.12mm	22.5°
	V		26.8°		22.5°		18.0°

M2514-SW

- 2/3"
- SWIR
- FIX
- MANUAL

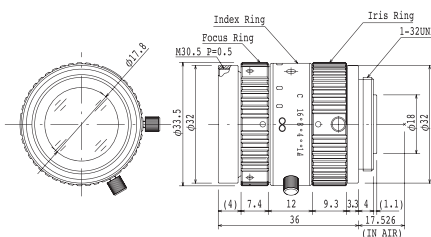

Focal Length	25mm		
Max. Aperture Ratio	1:1.4		
Max. Image Circle	φ 12.3mm		
Operation Range	Iris	F1.4 - F16C	
	Focus	0.3m - Inf.	
Control	Iris	Manual	
	Focus	Manual	
Object Dimension at M.O.D.	10.5(H)cm x 7.8(V)cm 2/3"		
Angle of View	D	24.7°	18.1°
	H	2/3" 19.8°	1/2" 14.5°
	V	14.9°	10.9°
Operating Temperature	-10° C ~ +50° C		

Distortion	2/3"	-0.5% (y=5.5)	1/2"	-0.2% (y=4.0)
Back Focal Length	13.4mm (Inf)			
Flange Back Length	17.526mm			
Mount	C-Mount			
Filter Size	M30.5 P=0.5mm			
Dimensions	φ 33.5mm x 36.0mm			
Weight	71.2g			

Angle of View (InGaAs Detector)	D	640 x 512 (Pixel Pitch : 15µm)	27.6°	320 x 256 (Pixel Pitch : 25µm)	23.0°	320 x 256 (Pixel Pitch : 20µm)	18.5°
	H	H9.60mm x V7.68mm	21.6°	H8.00mm x V6.40mm	18.1°	H6.40mm x V5.12mm	14.5°
	V		17.3°		14.5°		11.6°



- Designed for SWIR (800-1700nm) range
- Compact & light weight

- Low F-stop
- Covers 640 x 512, 15µm sensor

M3514-SW

- 2/3"
- SWIR
- FIX
- MANUAL

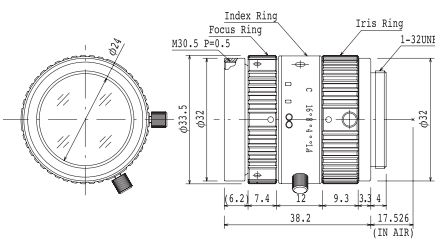

Focal Length	35mm		
Max. Aperture Ratio	1:1.4		
Max. Image Circle	φ 12.3mm		
Operation Range	Iris	F1.4 - F16C	
	Focus	0.3m - Inf.	
Control	Iris	Manual	
	Focus	Manual	
Object Dimension at M.O.D.	8.0(H)cm x 6.0(V)cm 2/3"		
Angle of View	D	18.4°	13.4°
	H	2/3" 14.7°	1/2" 10.7°
	V	11.1°	8.1°
Operating Temperature	-10° C ~ +50° C		

Distortion	2/3"	-0.1% (y=5.5)	1/2"	-0% (y=4.0)
Back Focal Length	14.6mm			
Flange Back Length	17.526mm			
Mount	C-Mount			
Filter Size	M30.5 P=0.5mm			
Dimensions	φ 33.5mm x 38.2mm			
Weight	87g			

Angle of View (InGaAs Detector)	D	640 x 512 (Pixel Pitch : 15µm)	20.5°	320 x 256 (Pixel Pitch : 25µm)	17.1°	320 x 256 (Pixel Pitch : 20µm)	13.7°
	H	H9.60mm x V7.68mm	16.0°	H8.00mm x V6.40mm	13.4°	H6.40mm x V5.12mm	10.7°
	V		12.9°		10.7°		8.6°

M5018-SW

- 2/3"
- SWIR
- FIX
- MANUAL

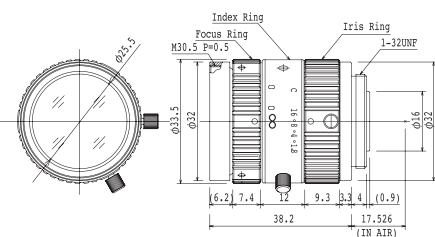

Focal Length	50mm		
Max. Aperture Ratio	1:1.8		
Max. Image Circle	φ 12.3mm		
Operation Range	Iris	F1.8 - F16C	
	Focus	0.6m - Inf.	
Control	Iris	Manual	
	Focus	Manual	
Object Dimension at M.O.D.	10.4(H)cm x 7.8(V)cm 2/3"		
Angle of View	D	13.0°	9.5°
	H	2/3" 10.4°	1/2" 7.6°
	V	7.8°	5.7°
Operating Temperature	-10° C ~ +50° C		

Distortion	2/3"	-0.3% (y=5.5)	1/2"	-0.1% (y=4.0)
Back Focal Length	13.6mm			
Flange Back Length	17.526mm			
Mount	C-Mount			
Filter Size	M30.5 P=0.5mm			
Dimensions	φ 33.5mm x 38.2mm			
Weight	85g			

Angle of View (InGaAs Detector)	D	640 x 512 (Pixel Pitch : 15µm)	14.5°	320 x 256 (Pixel Pitch : 25µm)	12.1°	320 x 256 (Pixel Pitch : 20µm)	9.7°
	H	H9.60mm x V7.68mm	11.3°	H8.00mm x V6.40mm	9.5°	H6.40mm x V5.12mm	7.6°
	V		9.1°		7.6°		6.1°



5MP Lens for ITS

INTELLIGENT TRANSPORT SYSTEM LENS

- 3-Iris type. Manual, DC and P-iris
- Wide Variety range, 9mm, 12mm, 16mm, 25mm

- High resolution for 5MP sensors

M0918FIC-MP

M1218FIC-MP

M1616FIC-MP

M2514FIC-MP

- 2/3"
- 5MP
- FIX
- MANUAL



MG0918KC-MP

MG1218KC-MP

MG1616KC-MP

MG2514KC-MP

- 2/3"
- 5MP
- FIX
- P-iris



ITS LENS

	Model Name	Format	Mount	Focal length (mm)	Aperture (F)
Manual Iris	M0918FIC-MP	2/3	C	9	1.8-16C
	M1218FIC-MP	2/3	C	12	1.8-16C
	M1616FIC-MP	2/3	C	16	1.6-16C
	M2514FIC-MP	2/3	C	25	1.4-16C
DC Iris	MG0918FC-MP	2/3	C	9	1.8-360C
	MG1218FC-MP	2/3	C	12	1.8-360C
	MG1616FC-MP	2/3	C	16	1.6-360C
	MG2514FC-MP	2/3	C	25	1.4-360C
P Iris	MG0918KC-MP	2/3	C	9	1.8-16C
	MG1218KC-MP	2/3	C	12	1.8-16C
	MG1616KC-MP	2/3	C	16	1.6-16C
	MG2514KC-MP	2/3	C	25	1.4-16C



5MP Lens for ITS (IR Compatible)

INTELLIGENT TRANSPORT SYSTEM LENS

ITS IR

- 3-Iris type. Manual, DC and P-iris
- Compatible with CMOSIS sensor "CMV2000"

- High resolution for 5MP sensors
- IR Compatible

M2514FIC-MPIR

M3518FIC-MPIR

M5020FIC-MPIR

- 2/3"
- 5MP
- IR
- FIX
- MANUAL



MG2514KC-MPIR

MG3518KC-MPIR

MG5020KC-MPIR

- 2/3"
- 5MP
- IR
- FIX
- P-iris



ITS LENS (IR Compatible)

	Model Name	Format	Mount	Focal length (mm)	Aperture (F)
Manual Iris	M2514FIC-MPIR	2/3	C	25	1.4-16C
	M3518FIC-MPIR	2/3	C	35	1.9-16C
	M5020FIC-MPIR	2/3	C	50	2.0-16C
DC Iris	MG2514FC-MPIR	2/3	C	25	1.4-360C
	MG3518FC-MPIR	2/3	C	35	1.8-360C
	MG5020FC-MPIR	2/3	C	50	2.0-360C
P Iris	MG2514KC-MPIR	2/3	C	25	1.4-16C
	MG3518KC-MPIR	2/3	C	35	1.8-16C
	MG5020KC-MPIR	2/3	C	50	2.0-16C





MEGAPIXEL BOARD LENS

MACHINE VISION LENS

NEW

4K BOARD LENS

1/1.8" 4K IR FIX BOARD

• Compatible with 1/1.8" Sensor • IR Corrected • 4K Ultra-High Resolution.



E3828KRW



E5228KRW

No.	Model Name	Format Inch	Mount	Pitch	Focal Length (mm)	Aperture (F)	Angle of view at INF(degrees)			Angle of view at INF(degrees)			Angle of view at INF(degrees)		
							1/1.8"			1/2"			1/3"		
							D	H	V	D	H	V	D	H	V
1	E3828KRW	1/1.8	M12	0.5	3.8mm	F2.8	133	107	80.7	120	96.2	72.4	90.3	72.4	54.3
2	E5228KRW	1/1.8	M12	0.5	5.2mm	F2.8	100	78.6	58.2	89.0	70.1	52.0	65.5	52.0	38.8

NEW

2 MEGAPIXEL BOARD LENS

1/2.8" 2MP IR FIX BOARD

• Compatible with 1/2.8" Sensor • IR Corrected • Metal Housing



T2820KP

No.	Model Name	Format Inch	Mount	Pitch	Focal Length (mm)	Aperture (F)	Angle of view at INF(degrees)			Angle of view at INF(degrees)			Angle of view at INF(degrees)			IRCF
							1/2.8"			1/3"			1/4"			
							D	H	V	D	H	V	D	H	V	
1	T2820KP	1/2.8	M12	0.5	2.8mm	F2.0	139	116	71.2	129.0	102	75.3	94.8	75.3	56.2	×
2	T2820KF3P	1/2.8	M12	0.5	2.8mm	F2.0	139	116	71.2	129.0	102	75.3	94.8	75.3	56.2	○

1 MEGAPIXEL BOARD LENS

1/2" 1MP FIX BOARD

• Compatible with 1/2" Sensor • Tough and compact design • M12, P0.5 mount



H0320KP



H0624KP

No.	Model Name	Format Inch	Mount	Pitch	Focal Length (mm)	Aperture (F)	Distortion	Angle of view at INF(degrees)			Angle of view at INF(degrees)			Angle of view at INF(degrees)		
								1/2"			1/3"			1/4"		
								D	H	V	D	H	V	D	H	V
1	H0320KP	1/2	M12	0.5	3mm	F2.0	-37.5%	125.3	104.3	80.5	98.6	80.5	61.3	75.8	61.3	46.3
2	H0624KP	1/2	M12	0.5	6mm	F2.4	-9.0%	72.5	59.1	45.0	55.6	45.0	34.0	42.3	34.0	25.6
3	H0924KP	1/2	M12	0.5	9mm	F2.4	-1.6%	48.6	39.6	30.1	37.3	30.1	22.7	28.3	22.7	17.1
4	H1620KP	1/2	M12	0.5	16mm	F2.0	0.4%	27.9	22.6	17.0	21.2	17.0	12.8	16.0	12.8	9.6
5	H2520KP	1/2	M12	0.5	25mm	F2.0	1.0%	18.0	14.5	10.9	13.6	10.9	8.2	10.3	8.2	6.2

3 MEGAPIXEL ULTRA LOW DISTORTION BOARD LENS

1/1.8" 3MP FIX BOARD

• Ultra low distortion (optical distortion 0.1% or less) • Compatible with 1/1.8" Sensor • M12, P0.5 mount • Tough and compact design



E1220KV



E2520KV

No.	Model Name	Format Inch	Mount	Pitch	Focal Length (mm)	Aperture (F)	Distortion	Angle of view at INF(degrees)			Angle of view at INF(degrees)			Angle of view at INF(degrees)		
								1/1.8"			1/2"			1/3"		
								D	H	V	D	H	V	D	H	V
1	E1220KV	1/1.8	M12	0.5	12.0mm	F2.0	0.04%	39.5	32.1	24.4	36.8	29.8	22.6	28.1	22.6	17.1
2	E1620KV	1/1.8	M12	0.5	16.0mm	F2.0	-0.07%	30.0	24.3	18.4	27.9	22.6	17.0	21.2	17.0	12.8
3	E2520KV	1/1.8	M12	0.5	25.0mm	F2.0	0.02%	19.5	15.7	11.9	18.1	14.6	11.0	13.7	11.0	8.2

MEGAPIXEL FISHEYE BOARD LENS

MACHINE VISION LENS

FISHEYE BOARD LENS

NEW

4K FISHEYE BOARD LENS

1/1.7"

4K

IR

FIX

FISHEYE

- Compatible with 1/1.7" Sensor • IR Corrected • 12MP Ultra-High Resolution
- ImmerVision enables Compatibles (E1222KRY, E1222KF3RY)



E1628KRY

E1222KRY

No.	Model Name	Format Inch	Mount	Pitch	Focal Length (mm)	Aperture (F)	Angle of view at INF(degrees)			Angle of view at INF(degrees)			Angle of view at INF(degrees)			IRCF
							1/1.7"			1/3"			1/4"			
							D	H	V	D	H	V	D	H	V	
1	E1628KRY	1/1.7	M12	0.5	1.6mm	F2.8	190.0	190.0	168.2	11.6	157.3	125.5	94.2	×		
2	E1222KRY	1/1.7	M12	0.5	1.2mm	F2.2	185.0	185.0	171.5	139.5	164.2	139.5	110.3	×		
3	E1628KF3RY*	1/1.7	M12	0.5	1.6mm	F2.8	190.0	190.0	168.2	11.6	157.3	125.5	94.2	○		
4	E1222KF3RY*	1/1.7	M12	0.5	1.2mm	F2.2	185.0	185.0	171.5	139.5	164.2	139.5	110.3	○		

*Please note E1628KF3RY and E1222KF3RY are produced to order.

MEGAPIXEL FISHEYE BOARD LENS

1/2"

1MP

FIX

FISHEYE

- Compatible with 1/2" Sensor • 2MP High Resolution • ImmerVision enables Compatibles



H1328KP

No.	Model Name	Format Inch	Mount	Pitch	Focal Length (mm)	Aperture (F)	Angle of view at INF(degrees)			Angle of view at INF(degrees)			Angle of view at INF(degrees)		
							1/2"			1/3"			1/4"		
							D	H	V	D	H	V	D	H	V
1	H1328KP	1/2	M12	0.5	1.3mm	F2.8	180.0	180.0	151.0	177.3	151.0	117.6			

5 MEGAPIXEL FISHEYE BOARD LENS

1/2.5"

5MP

IR

FIX

FISHEYE

- Compatible with 1/2.5" Sensor • IR Corrected • 5MP High Resolution • IP66 (L1028KDRW) • ImmerVision enables Compatibles



L1028KRW

L1028KDRW

No.	Model Name	Format Inch	Mount	Pitch	Focal Length (mm)	Aperture (F)	Angle of view at INF(degrees)			Angle of view at INF(degrees)			Angle of view at INF(degrees)			Water Proof
							1/2.5"			1/3"			1/4"			
							D	H	V	D	H	V	D	H	V	
1	L1028KRW	1/2.5	M12	0.5	1.05mm	F2.8	180.0	180.0	163.2	180.0	163.2	130.2				
2	L1028KDRW	1/2.5	M12	0.5	1.05mm	F2.8	180.0	180.0	163.2	180.0	163.2	130.2	○			

3 MEGAPIXEL FISHEYE BOARD LENS

1/3"

3MP

IR

FIX

FISHEYE

- Compatible with 1/3" Sensor • IR Corrected • 3MP High Resolution • ImmerVision enables Compatibles



T0928KRW

No.	Model Name	Format Inch	Mount	Pitch	Focal Length (mm)	Aperture (F)	Angle of view at INF(degrees)			Angle of view at INF(degrees)			Angle of view at INF(degrees)		
							1/2"			1/3"			1/4"		
							D	H	V	D	H	V	D	H	V
1	T0928KRW	1/3	M12	0.5	0.95mm	F2.8	-	180.0	180.0	145.2					

1. Calculation of Working Distance (WD)

Distance from lens to object (WD) is calculated by putting the size of a camera's imaging device, focal length and an object size into the following formula.

<Formula>
 $WD = H1 + y \times f / y'$

[Ex]
 When 2/3" camera with M2514-MP films an object whose vertical size is 120 mm.
 f : 25 mm
 H1 : 26.77mm
 y : 120mm
 y' : 6.6mm

Distance from lens to object=
 $WD = 26.77 + 120 \times 25 / 6.6 = 481.32 \text{ mm}$

2. Calculation of Focal Length

When choosing size of a camera's imaging device, the object size and WD are fixed, focal length can be calculated by the following formula. You can select appropriate lens from the focal length.

<Formula>
 $f = y' \times WD / y$

f = focal length of lens
 WD = distance from lens to object
 H1 : first principal point
 y : vertical size of object
 y' : vertical size of camera's imaging device

CAMERA FORMAT

The size of camera's imaging device also affects the angle of view, with the smaller devices creating narrower angles of view when used on the same lens. The format of the lens, however is irrelevant to the angle of view, it merely needs to project an image which will cover the device, i.e.; the same format of the camera or larger. This also means that 1/3" cameras can utilize the entire range of lenses from 1/3" to 2/3", with a 1/3" 8mm lens giving the same angle as a 2/3" 8mm lens. The latter combination also provides increased resolution and picture quality as only the centre of the lens is being utilized, where the optics can be ground more accurately.

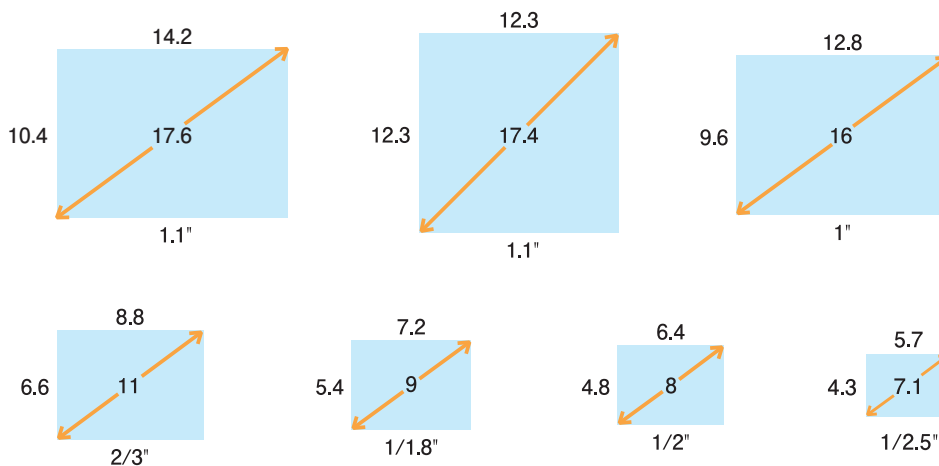
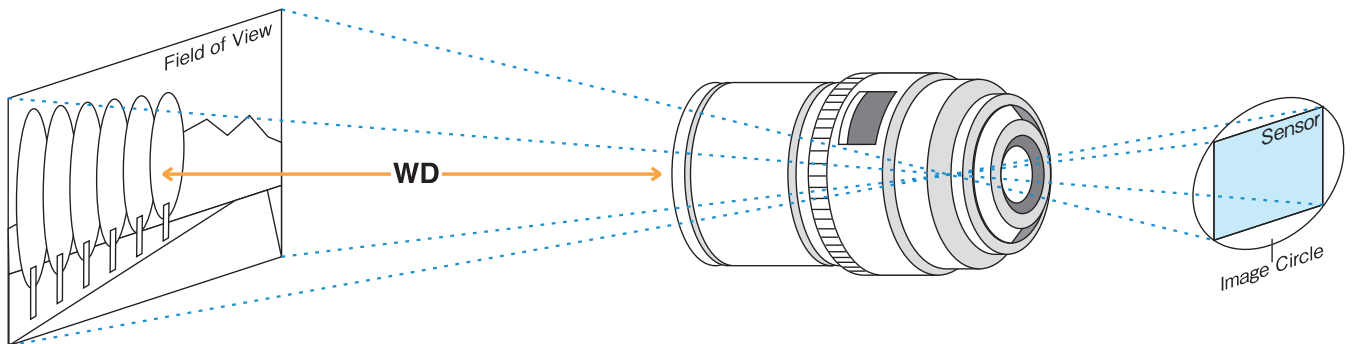

OPTICAL DATA

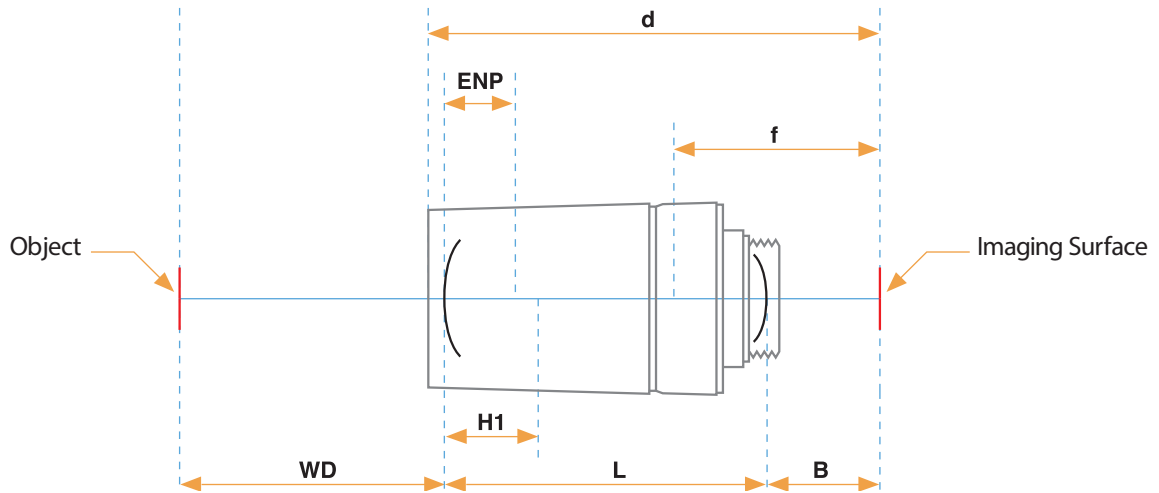

	Focal Length	First Principal Point	Total Length	Back Focus	Entrance Pupil Diameter	Entrance Pupil Position	Distortion	Extension	Length	
	(f)	(H1)	(L)	(B)		(ENP)			(d)	
MEGAPIXEL LENS										
H0514-MP2	5.1	20.2	50.5	10.8	3.5	15.0	-0.7	0.1	63.0	
M0814-MP2	8.3	19.5	30.7	13.1	5.8	12.4	-0.1	0.2	45.7	
M1214-MP2	12.0	24.7	28.7	13.1	8.4	17.7	0.1	0.4	45.7	
M1614-MP2	16.0	26.2	29.7	13.1	11.2	14.3	-0.1	0.8	45.7	
M2514-MP2	25.0	23.8	29.3	13.1	17.5	12.8	-0.3	2.0	53.5	
M3514-MP	34.0	43.7	37.6	15.2	24.0	37.3	-0.3	4.9	55.7	
M5018-MP2	48.0	22.1	40.9	13.1	25.9	52.8	-0.3	4.8	55.6	
M7528-MP	72.6	111.5	55.2	13.7	24.8	47.8	0.2	15.5	71.0	
M0824-MPW2	8.0	20.0	42.4	13.7	3.4	13.5	-1.87	-0.3	59.0	
M1224-MPW2	12.0	23.5	39.0	14.4	5.1	16.0	-0.02	1.75	58.0	
M1620-MPW2	16.0	23.9	27.9	14.7	8.0	15.8	0.09	3.3	47.0	
M2518-MPW2	25.0	27.4	28.3	13.8	13.9	20.8	0.03	4.3	49.0	
M3520-MPW2	35.0	14.0	25.7	18.0	17.5	20.4	0.01	7.3	50.9	
M5028-MPW2	50.0	7.4	27.8	27.7	17.9	21.3	0.03	7.3	58.9	
M2518-MPW	25.0	27.4	27.1	13.9	13.9	20.8	0.03	6.2	61.7	
V0828-MPY	8.2	22.7	69.8	8.6	2.9	16.1	-0.6	0.8	71.5	
V1228-MPY	12.4	22.3	51.8	8.4	4.3	13.3	-0.5	0.9	53.7	
V1628-MPY	16.0	19.9	48.6	9.4	5.6	11.6	-0.5	1.1	53.8	
V2528-MPY	25.0	18.0	37.5	11.3	8.7	12.9	0.3	3.5	51.5	
V3528-MPY	35.0	15.6	46.7	11.7	12.2	17.3	-0.1	4.8	62.7	
V5028-MPY	50.0	9.5	54.2	11.9	17.3	23.2	0.1	8.6	62.7	
V0814-MP	8.25	24.3	74.1	11.7	5.7	17.1	-7.1	0.6	75.5	
V1214-MP	12.7	25.2	67.4	12.6	8.8	14.7	-5.9	1.4	69.0	
V1614-MP	16.2	25.3	57.3	12.1	11.3	10.8	-3.8	0.9	66.0	
V2514-MP	25.0	30.9	49.2	15.7	17.2	18.3	-3.1	2.0	60.1	
V5014-MP	50.0	38.8	62.2	14.6	34.7	66.5	0.8	5.1	65.5	
MACRO ZOOM LENS										
MLH-10X	0.15m wide	18.8	91.3	87.2	23.4	3.8	3.8	2.5	-	116.0
	0.15m Tele	68.7	-0.1	87.2	23.4	20.1	20.1	2.9	-	116.0
MEGAPIXEL MACRO ZOOM LENS										
MLM-3XMP	Wide	30.2	30.2	61.6	20.5	9.5	38.9	0.4	-	97.0
	Tele	29.1	44.7	61.6	20.5	61.4	313.8	2.3	-	97.0
TELECENTRIC LENS										
TEC-M55	54.8	27.8	47.3	31.4	20.1	75.1	0.4	27.4	83.0	
x0.75	41.2	51.6	64.0	14.7	19.8	73.8	-0.9	27.4	83.0	
x2.0	95.7	83.7	68.8	24.9	19.8	73.8	0.4	27.4	83.0	
TEC-M55MPW	55.0	17.3	67.6	17.0	19.6	71.4	0.52	-	110.6	
TELECENTRIC MACRO ZOOM LENS										
TEC-V7X	Tele	106.3	-136.1	122.4	39.5	53.6	375.0	1.0	-	166.4
	Wide	47.7	-143.1	112.1	49.8	11.0	126.9	-1.7	-	166.4

* First principal point and entrance pupil position are calculated from front lens

America

CBC AMERICAS CORP. **North Carolina**

2000 Regency parkway, Suite 600
Cary, NC, 27518, U.S.A.
TEL : +1 919 230 8700
FAX : +1 919 230 2268
<http://www.computar.com>
computar@cbcamerica.com

CBC AMERICAS CORP. **Los Angeles Division**

21241 South Western Avenue, Suite #160
Torrance, CA 90501, U.S.A.
Tel : +1 310 222 8600
Fax : +1 310 797 0908
<http://www.computar.com>
computar@cbcamerica.com

CBC AMERICAS CORP. **Mexico Branch Office**

Galileo No. 20-101, Col. Polanco,
Miguel Hidalgo, 11560, Mexico DF
Tel : +52 55 5280 4660
Fax : +52 55 5280 3073
<http://www.computar.com>
computar@cbcamerica.com

Europe

CBC (EUROPE) GmbH **Düsseldorf**

Hansaallee 191
D-40549 Düsseldorf, GERMANY
Tel : +49 (0)211 53067 0
Fax : +49 (0)211 53067 180
<http://www.cbc-europe.com>
info@cbc-europe.com

CBC (EUROPE) GmbH UK Branch **London**

Unit 9, Garrick Road Industrial Estate,
Irving Way, London NW9 6AQ, U.K.
Tel : +44 (0)20 8732 3300
Fax : +44 (0)20 8202 3387
<http://www.cbceurope.com>
info@cbcuk.com

CBC (EUROPE) Srl **Milan**

Via E. Majorana, 2
20834-Nova Milanese(MB), ITALY
Tel : +39 0362 365079
Fax : +39 0362 40012
<http://www.computar.it>
<http://computarganz.it>
sales@cbceurope.it

CBC (Poland) Sp.z o.o. **Warszawa**

Ul. Anny German 15
01-794 Warszawa
Tel : +48 22 633 90 90
Fax : +48 22 633 90 60
<http://www.cbcpoland.pl>
info@cbcpoland.pl

CBC Co., Ltd. MOSCOW REP OFFICE **Moscow**

Office 503B, Entrance#3, Building 1,
World Trade Center, 12 Krasnopresnenskaya nab.,
Moscow, 123610, RUSSIA
Tel : +7 495 258 2161
Fax : +7 495 258 2160
<http://www.cbc.ru>
support@cbc.ru

China

CBC(Beijing) Trading CO.,LTD. **Beijing**

Room B905-A, Tian Yuan Gang Center,
No.C2 Dong San Huan Bei-Lu,
Chaoyang District,
Beijing, CHINA
Tel : +86 10 6410 8081 Fax : +86 10 6410 8085
<http://www.cbc-china.cn/10>
omata@bjcbc.com.cn

CBC (SHANGHAI) Trading CO., Ltd. **Shanghai**

Room 1801, GIFC, No.1438 HongQiao Road,
Changning District, Shanghai, CHINA
Tel : +86 21 3209 2626
Fax : +86 21 3209 2814
<http://www.cbc-china.cn/>
fanliang@cbcsh.com.cn

CBC (GUANGZHOU) Trading CO., Ltd. **Guangzhou**

Room 1207, CITIC Plaza, No.233 Tian He North
Road, Guangzhou City, Guangdong Province,
CHINA
Tel : +86 20 8752 0039
Fax : +86 20 8752 0131
<http://www.cbc-china.cn/>
lijianhua@gzcbc.com.cn

CBC (H.K.) CO., LTD. **Hong Kong**

Unit 901, 9/F, Tower 5,
China Hong Kong City, 33 Canton Road,
Tsim Sha Tsui, Kowloon, Hong Kong, CHINA
Tel : +852 2345 8686
Fax : +852 2887 2457
<http://www.cbc-china.cn/>
larrywong@cbc.com.hk

Asia

CBC. S Pte.Ltd. **Singapore.**

2 Leng Kee Road,
#03-04 Thye Hong Centre,
Singapore 159086
Tel : +65 6275 1221
Fax : +65 6475 0633
<http://www.cbcsingapore.com/>
kenny@cbcs.com.sg

CBC (Thailand) Co.,Ltd. **Bangkok**

23rd Floor, ITF Tower 2, 140/53-55
Silom Road, Suriyawongse,
Bangrak, Bangkok 10500
THAILAND
Tel : +66 2231 6181/2 +66 2231 6506/9
Fax : +66 2231 6180
<http://www.cbcthailand.com/>
kanya@cbcthai.com

CBC Corporation (India) Private Limited **Mumbai**

2nd floor B Wing, Marwah Centre,
Krishanlal Marwah Marg,
Andheri East, Mumbai 400 072, INDIA
Tel : +91 22 2857 9798/99
Fax : +91 22 6649 1708
enquiry@cbcindia.com

T-CBC (TAIWAN) CO., Ltd. **Taiwan**

Room D, 10th Floor, No.365 Fushing N. Rd.,
Taipei, 10543, TAIWAN, R. O. C.
Tel : +886 2 6600 8001
Fax : +886 2 6600 5211
<http://www.t-cbc.com.tw/>
cbc@t-cbc.com.tw

2017.08



Head Quarters

Image & Information Technology Division
2-15-13, Tsukishima, Chuo-ku, Tokyo 104-0052, Japan
TEL:+81(0)3 3536 4765 FAX:+81(0)3 3536 4771
www.cbc.co.jp

www.computar.com www.computar-global.com

Tokyo HQ Registered



Tokyo HQ Registered

